

GUIDE

HF680N

1.	1
1.1	1
1.2	5
1.3	5
2	6
2.1	6
2.2	6
2.3	7
2.4	9
2.4.1	9
2.4.2	10
2.4.3	11
2.4.4	12
3	14
3.1	14
3.2	14
3.3	21
3.4	23
3.5	24
3.6	26
3.7	26
3.7	27
3.8	27
4.	31

7.2.1			75
7.2.2			75
7.2.3			76
7.2.4			77
8			79
8.1			79
8.1.1			79
8.1.2			83
8.1.3			91
8.2			98
8.3			99
8.3.1			99
8.3.2			99
8.3.3			100
8.3.4			100
8.3.5			101
8.3.6			102
8.3.7			103
8.3.8			103
8.3.9			104
9			105
9.1			105
9.1.1			105
9.1.2			105
9.1.3			106
9.1.4			107
9.1.5			107
9.1.6			108
9.1.7 AFE			108
10			111
10.1		P2	111
10.2		P3	111
10.3		P4	113
10.4		P5	115
10.5		P6	117
10.6		P7	119
10.7	1	P8	122
10.8	2	P9	125
10.9	3	P10	128
10.10	4	P11	131
10.11	1	P12	134
10.12	2	P13	136
10.13	3	P14	138
10.14	4	P15	140
10.15	1	V/F P16	142
10.16	2	V/F P17	145
10.17	3	V/F P18	148
10.18	4	V/F P19	151

10. 19	1	P20.....	154
10. 20	2	P21.....	159
10. 21	3	P22.....	164
10. 22	4	P23.....	169
10. 23		P33.....	174
11.		184
11. 1		184
11. 2		185
11. 3		189
12		191
12. 1		191
12. 2		192
12. 3		192
12. 4		193
12. 5		193
		194

1.

1.1



1

RCM

RCD

HF680N02C- 400- 5

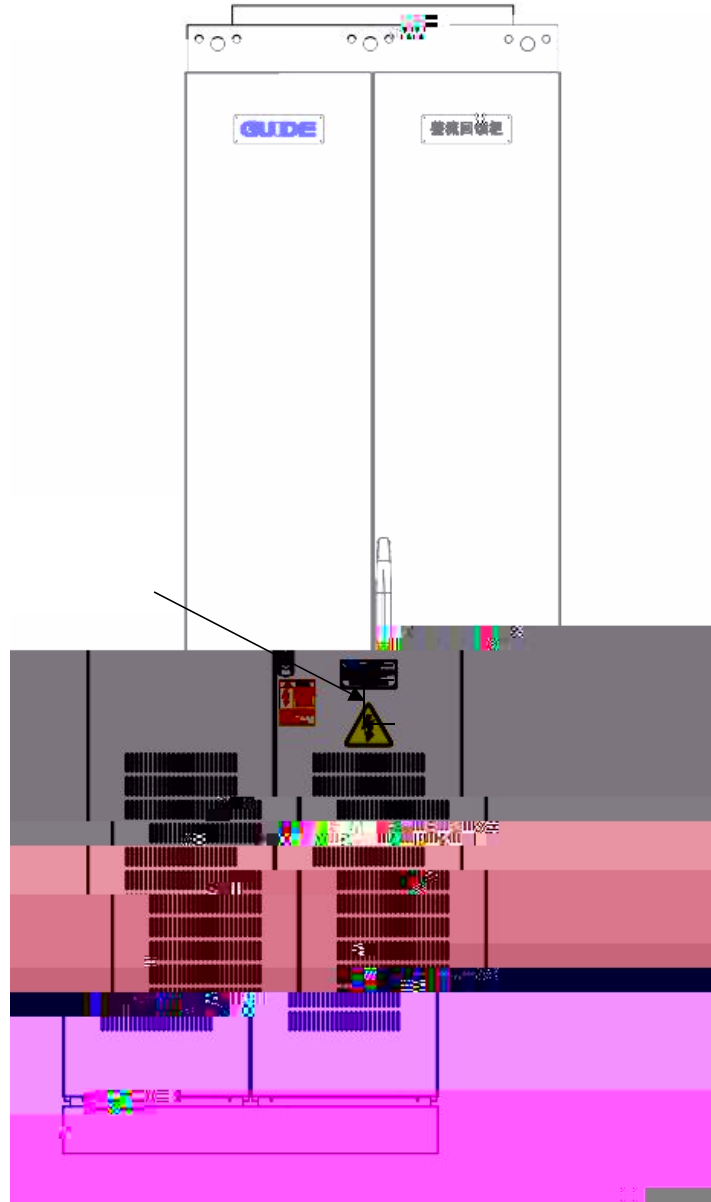

2

2.1

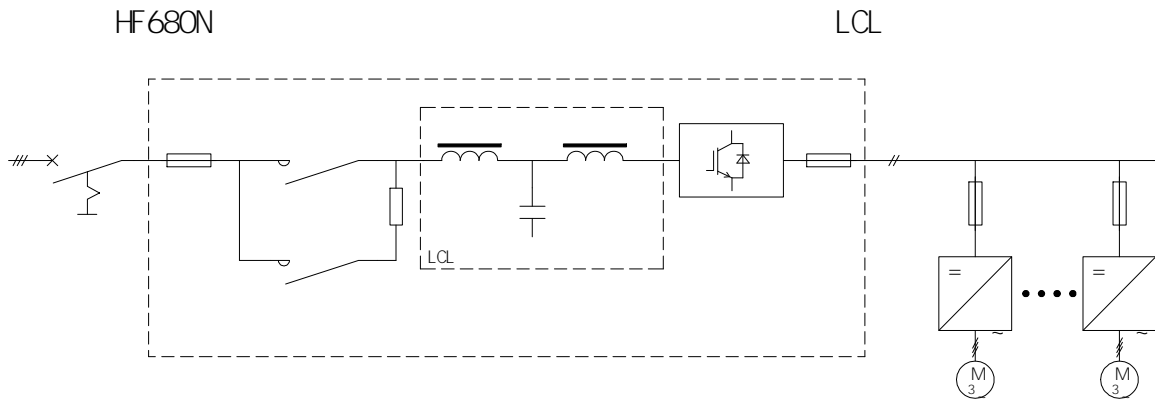

I GBT

AFE

DC24V

I GBT

2.2

1

AFE

2

		PI D
		/
		/
		HE
		/
		/

2 3

DP	GDHF - ADPX1	GDHF - ADPX1 DP HF 680N02M	Profibus HF 680N03M
PG	GDHF - APGX1	GDHF - APGX1 PG HF 680N03M	F6
PN		15V	PG



2.4

1.	/	"	"
2		/	
3.	-	P S T	
	-	U V W	
	-	P N	
4.			5
5.	,		,
1.			
2			
3.	40		
4.		1.2	

2.4.1

-
-
-
-
-
-

-20 +0
0 95%

1

5

2.4.2

●

●

-10 +40

+40 +50

1

2%

50

●

95%RH

●

●

●

●

●

●

1000

1000

100

1%

3000

2.4.3

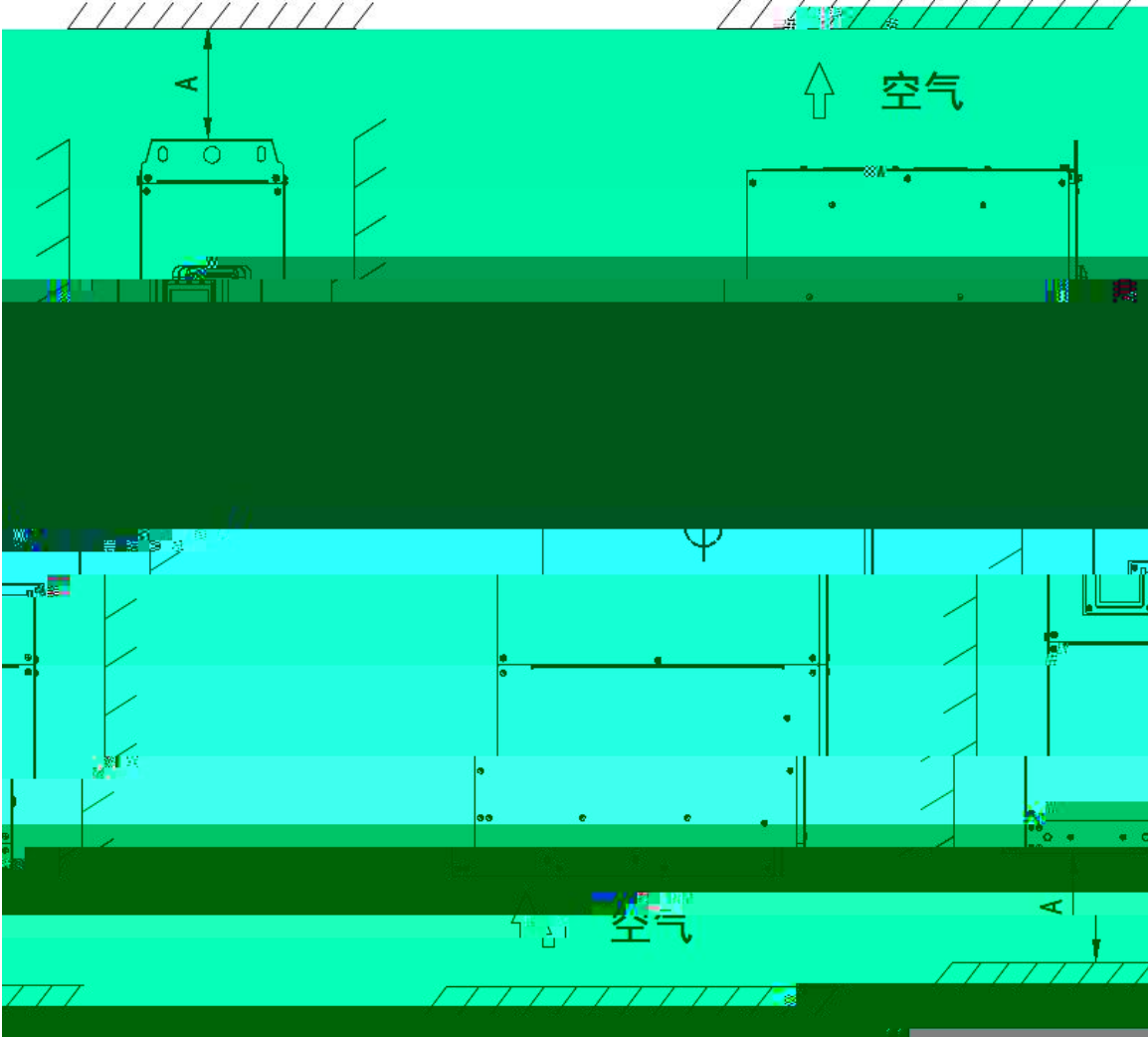

	A 200mm	B 50mm

50mm

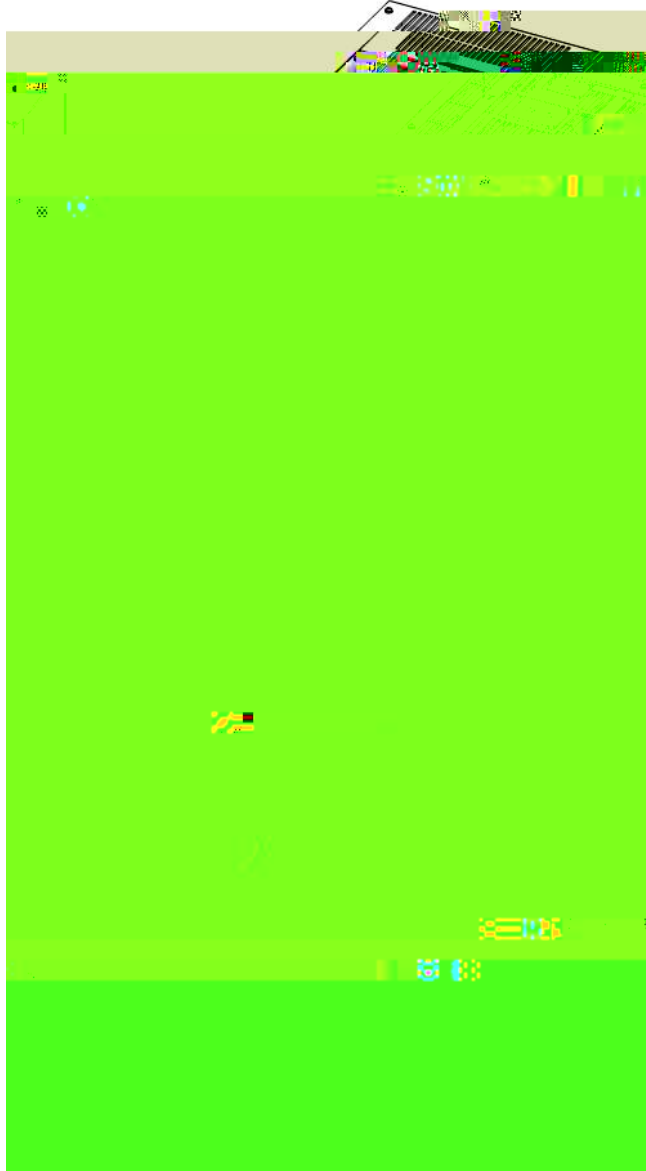

LCL

3.

3.1

LCL

LCL

3.2

1

P +	
N -	
R S T	
	

B4

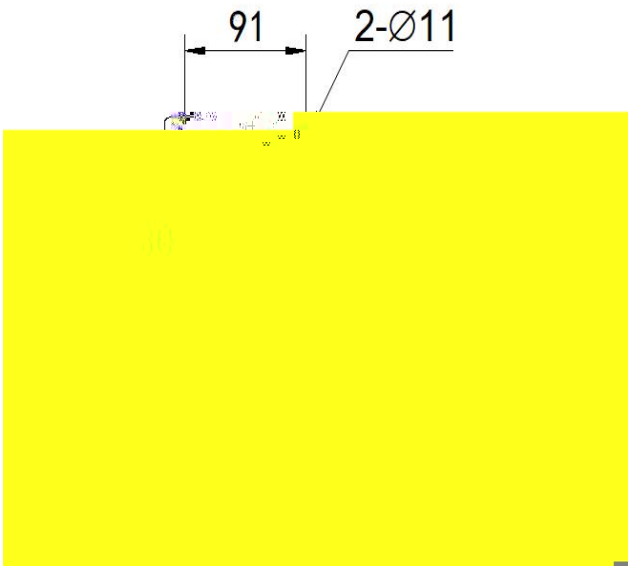
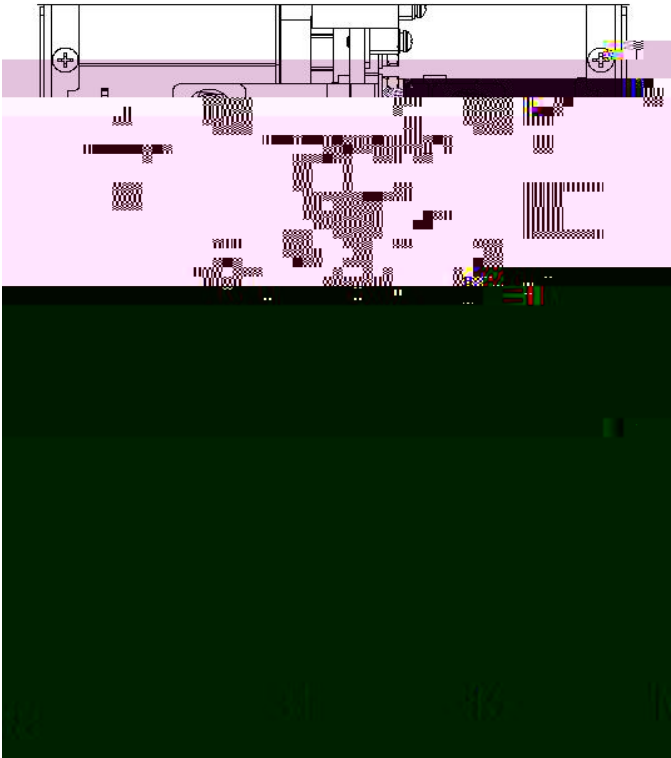

B5

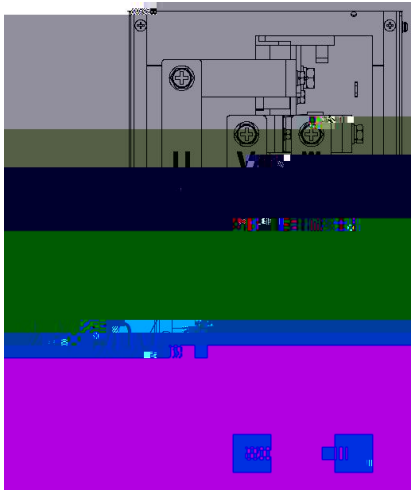

4-M10

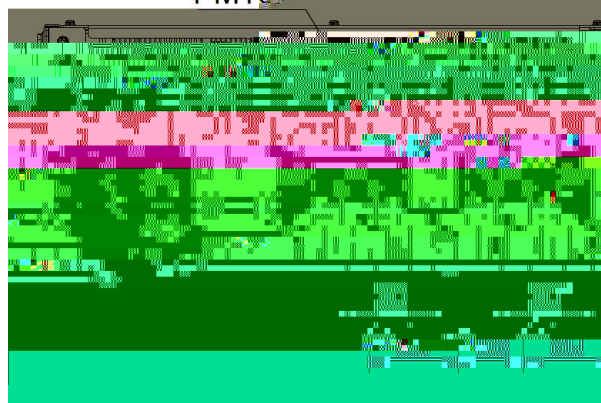

B6

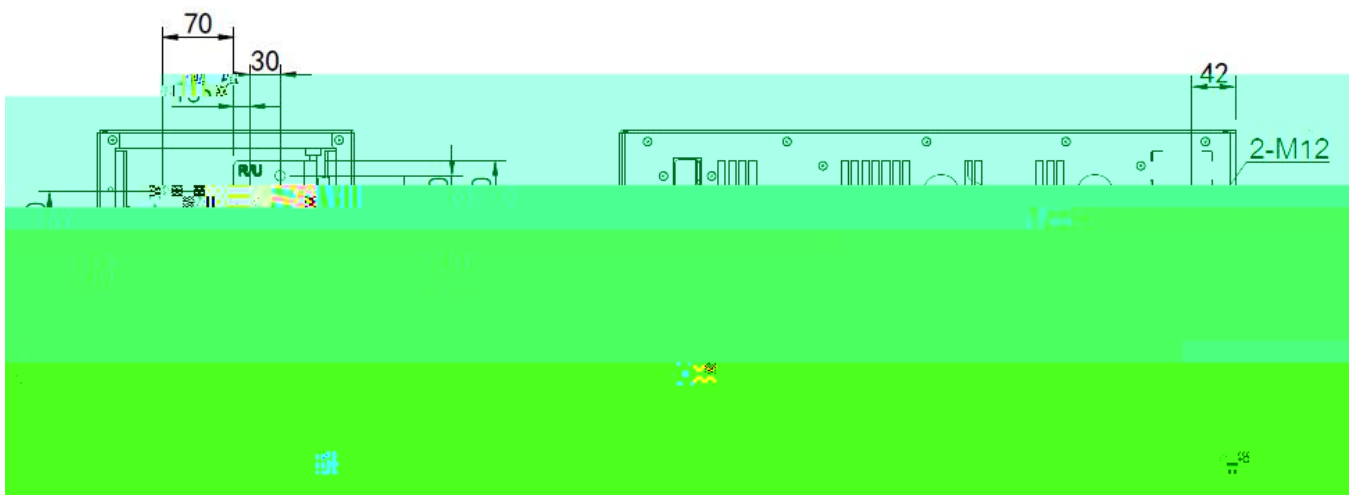

2 LCL

R S T	LCL
	LCL
P + N -	LCL
PTC	LCL

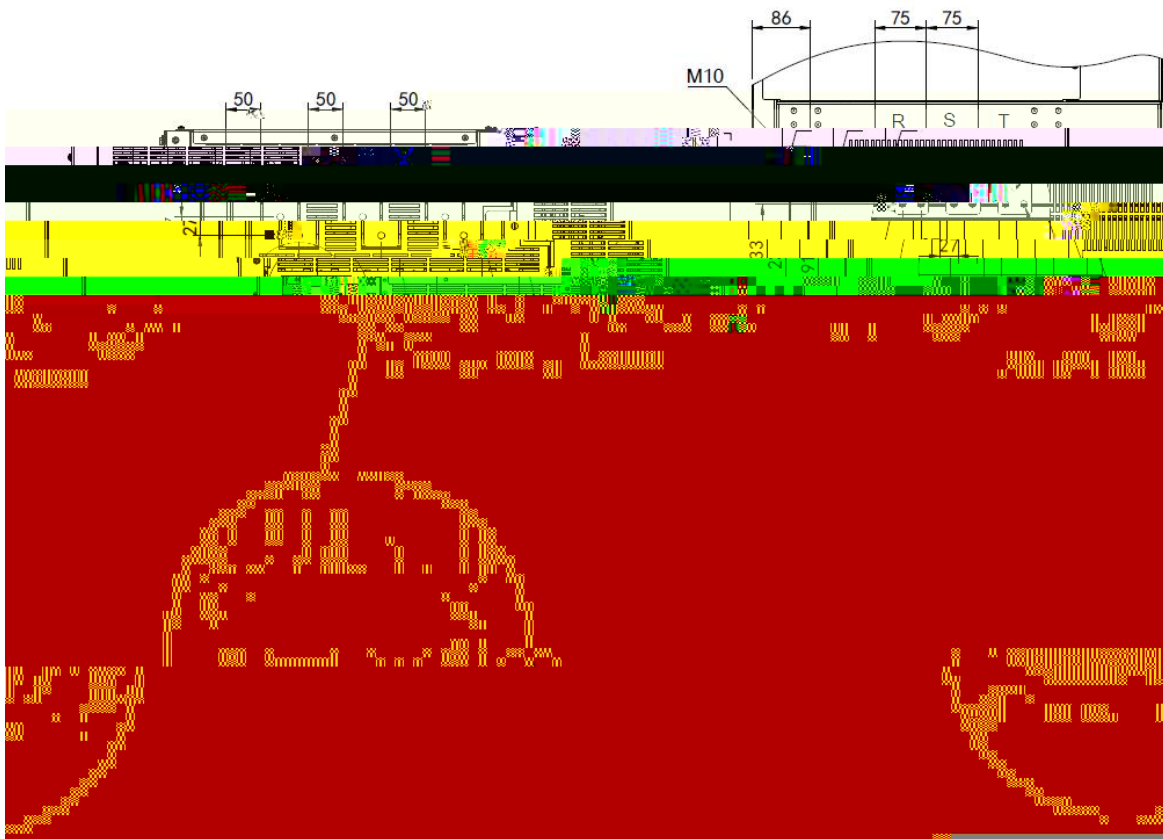

B6 LCL

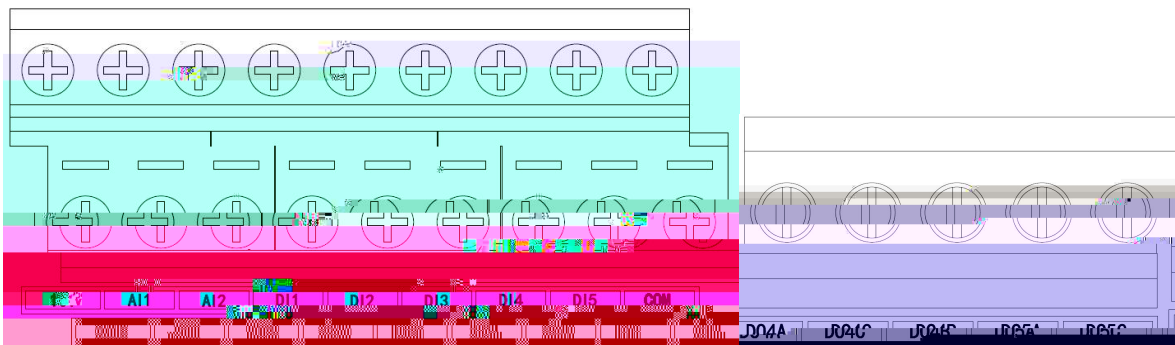
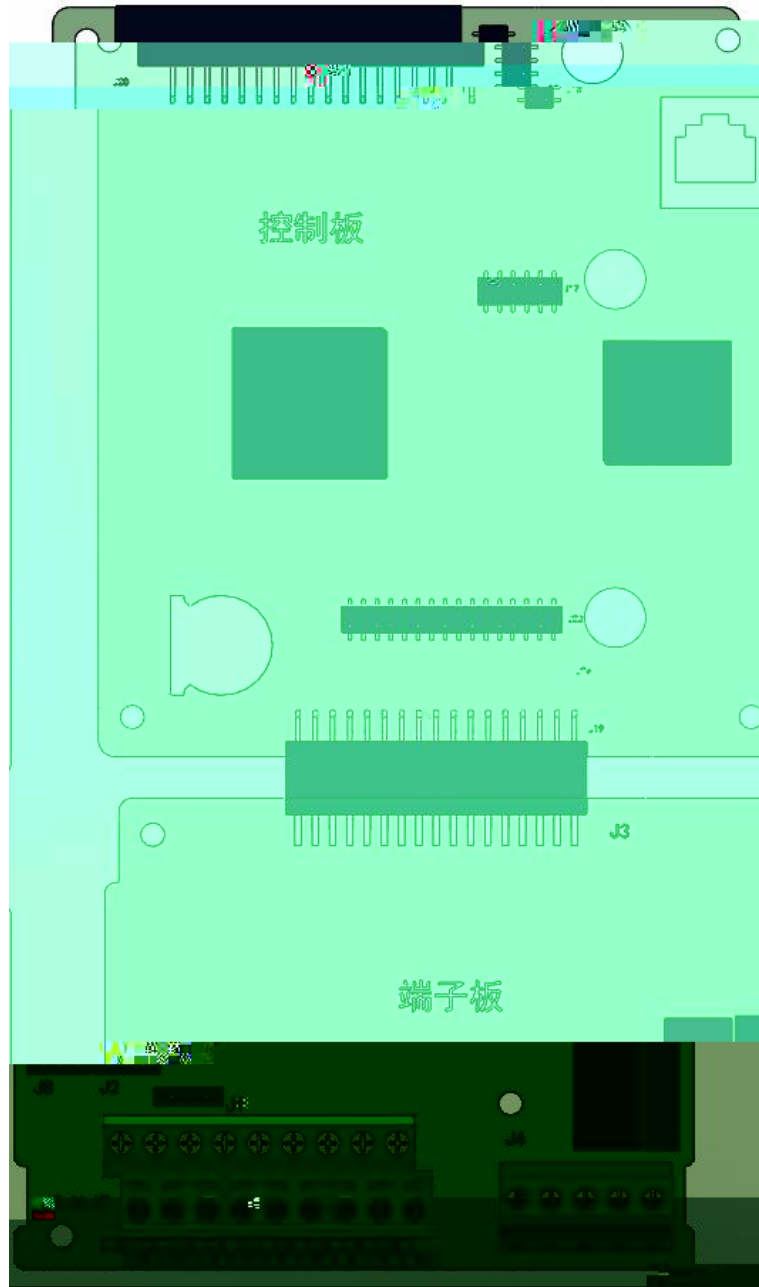

	+10V- GND	10V	+10V 50mA 1k ~5k
	+24V- COM	24V	+24V 200mA
	PW		24V DI 1-DI 5 DO1 PW 24V
	AI 1- GND	1	DC -10V~10V 100k
	AI 2- GND	2	J1 -10VDC~10VDC/0mA~20mA 100k 500
	DI 1- PW	1	500Hz DI 5 9V~30V DI 1-DI 4 20KHz 3.3k
	DI 2- PW	2	
	DI 3- PW	3	
	DI 4- PW	4	
	DI 5- PW	5	
	AO1- GND	1	J2 0V~10V 0mA~20mA
	AO2- GND	2	J8 0V~10V 0mA~20mA
	DO1- COM	1	0V~24V 0mA~50mA
	DO4A- DO4C	1	250VAC 3A COS =0.4 30VDC 1A
	DO4B- DO4C	2	
	DO5A- DO5C	3	250VAC 2A COS =0.4 30VDC 1A

	J1	AI 2	
	J2	AO1	
	J3	AO2	

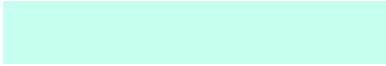

3.3

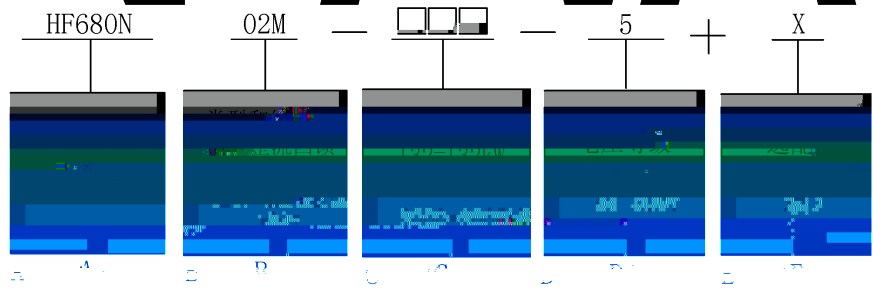

A	
B	O2M O2C
C	132 132kW 3000 3000kW
D	5 380V 5 500V
E	

MBO1	Mdbus RTU	DPO1	Pr of i bus DP
PN01	Profi net	CAN01	CANopen

	I ac A					Pdch kW	
		I dc A	Pdc kW	I dch A	Pdch kW		
HF680N02C- 2000- 5	2805	3400	2567	2649	2000	2000	B6* 4
HF680N02C- 2500- 5	3478	4215	3183	3311	2500	2500	B6* 5
HF680N02C- 3200- 5	4152	5032	3799	4238	3200	3200	B6* 6

- 1 HF680N02M
- 2 HF680N02M

3. 4

LCL

	LCL	
HF680N02M 160- 5	GDHF680N- LCL- 160- 5	3× 7R5
HF680N02M 220- 5	GDHF680N- LCL- 220- 5	3× 7R5
HF680N02M 315- 5	GDHF680N- LCL- 355- 5	3× 4R
HF680N02M 355- 5	GDHF680N- LCL- 355- 5	3× 2R5
HF680N02M 400- 5	GDHF680N- LCL- 450- 5	3× 2R5
HF680N02M 450- 5	GDHF680N- LCL- 450- 5	3× 2R5
HF680N02M 500- 5	GDHF680N- LCL- 560- 5	3× 2R5
HF680N02M 560- 5	GDHF680N- LCL- 560- 5	3× 2R5

"

"

LCL



3.6

		380V 500V
		50 / 60Hz
		-10% +10%
		<AC350V 15ms
		AFE
		0.999
		3%
		150% 5 1
		180% 5 1
		570 810V
		1kHz 10kHz

3.7

+LCL		kW
HF 680N02M 160- 5+GDHF 680N- LCL- 160- 5	B4	4.6
HF 680N02M 220- 5+GDHF 680N- LCL- 220- 5	B5	6.3
HF 680N02M 315- 5+GDHF 680N- LCL- 355- 5	B6	9.0
HF 680N02M 355- 5+GDHF 680N- LCL- 355- 5		10.1
HF 680N02M 400- 5+GDHF 680N- LCL- 450- 5		11.4
HF 680N02M 450- 5+GDHF 680N- LCL- 450- 5		12.8
HF 680N02M 500- 5+GDHF 680N- LCL- 560- 5		14.3
HF 680N02M 560- 5+GDHF 680N- LCL- 560- 5		16.0

3.7

- (1) IGBT
- (2) 50%
- (3) 0.999
- (4) 3% GB/T 24337-2009
- (5) 380V 500V -10% +10%
- (6) DP PN
- (7)
- (8) 160kW 3200kW

3.8

- 1
- 2 500kW
- 500kW



1 () a

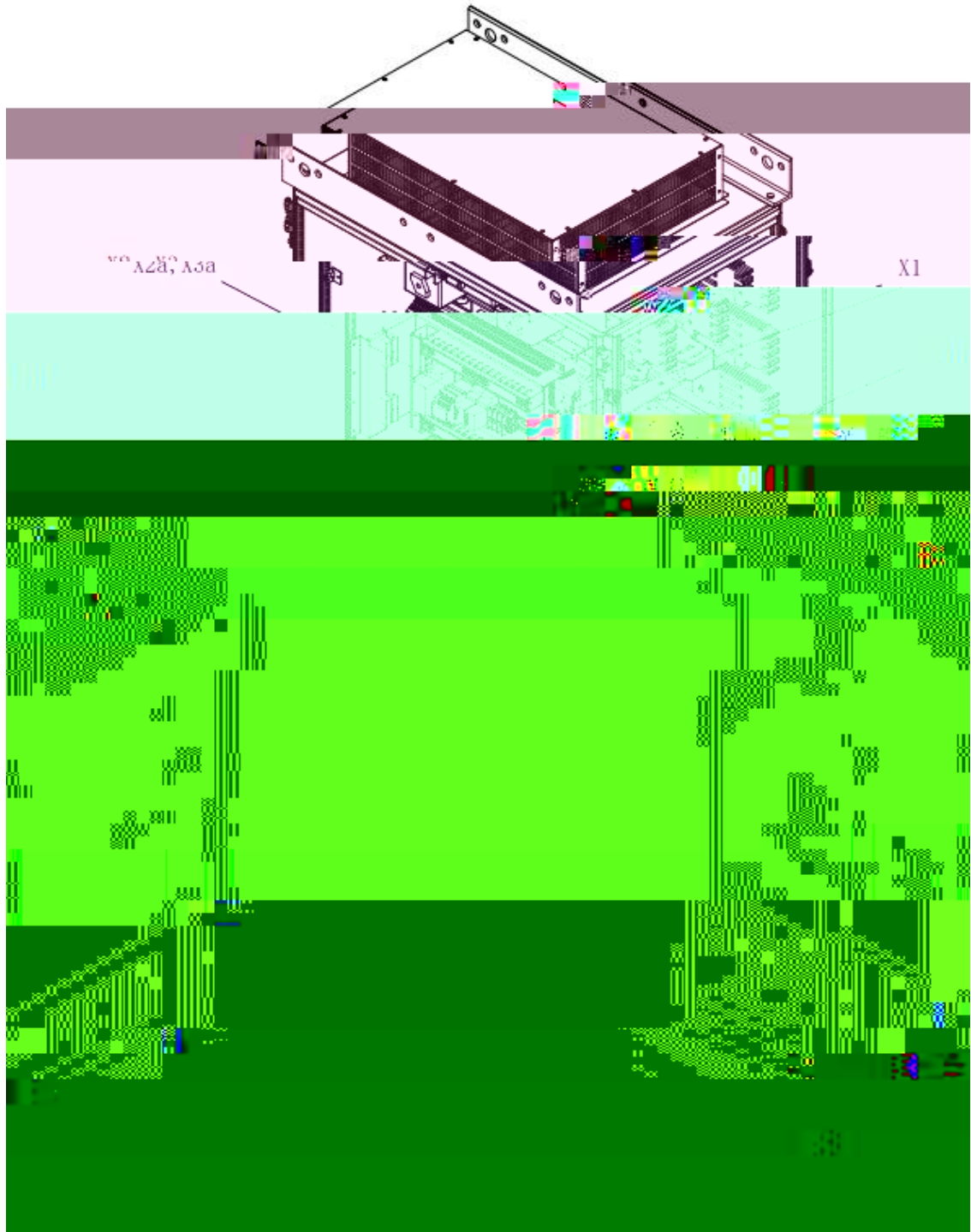

2

b

W W

B3

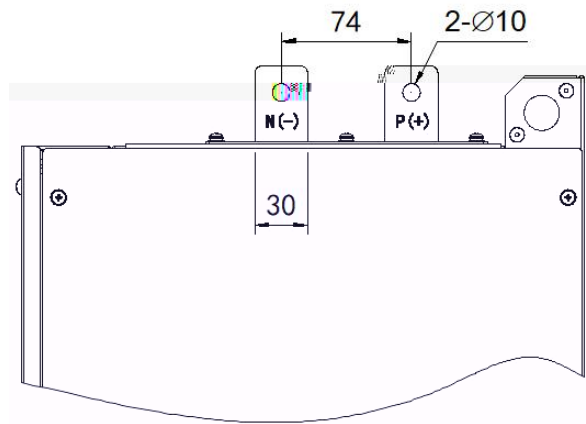
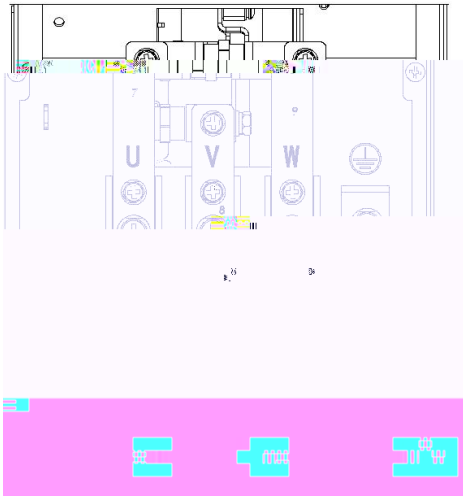

B4

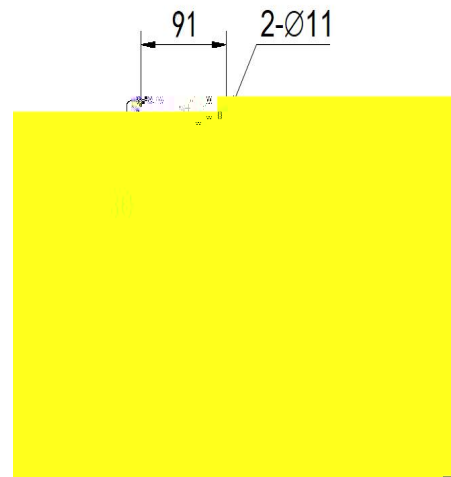
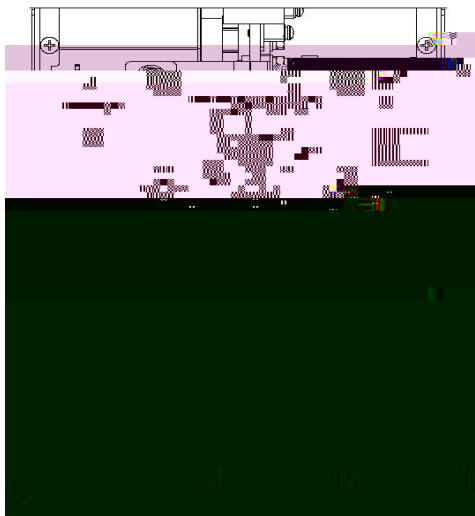

B5

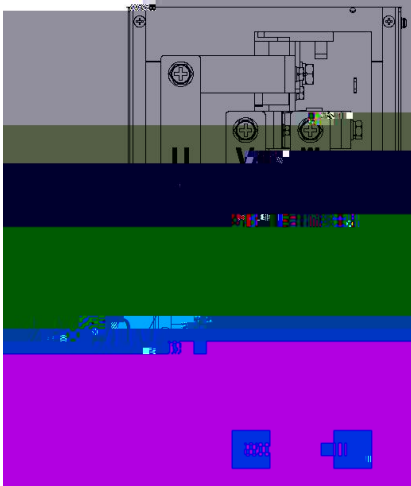

4-M10

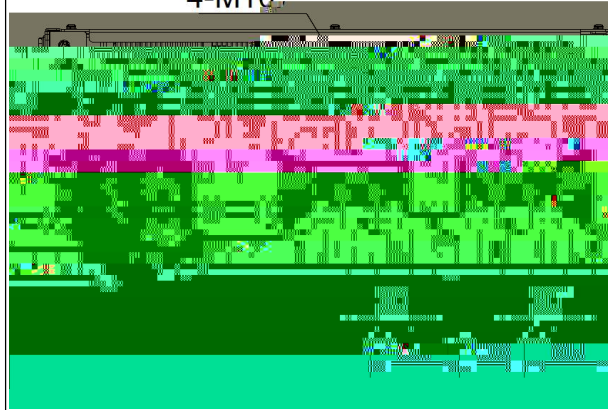

B6

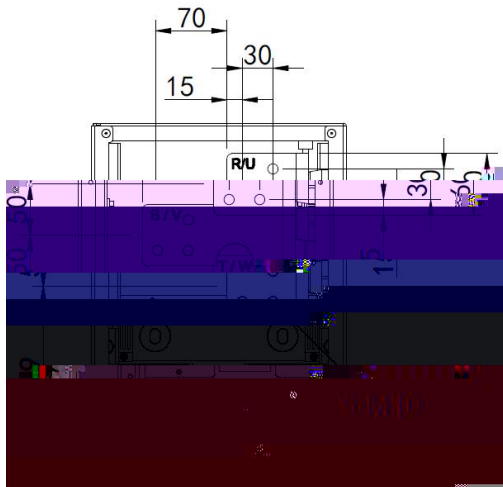

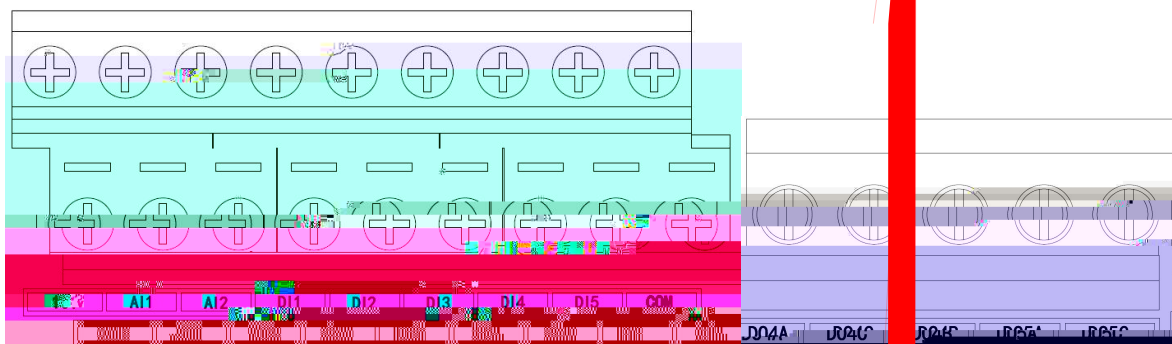
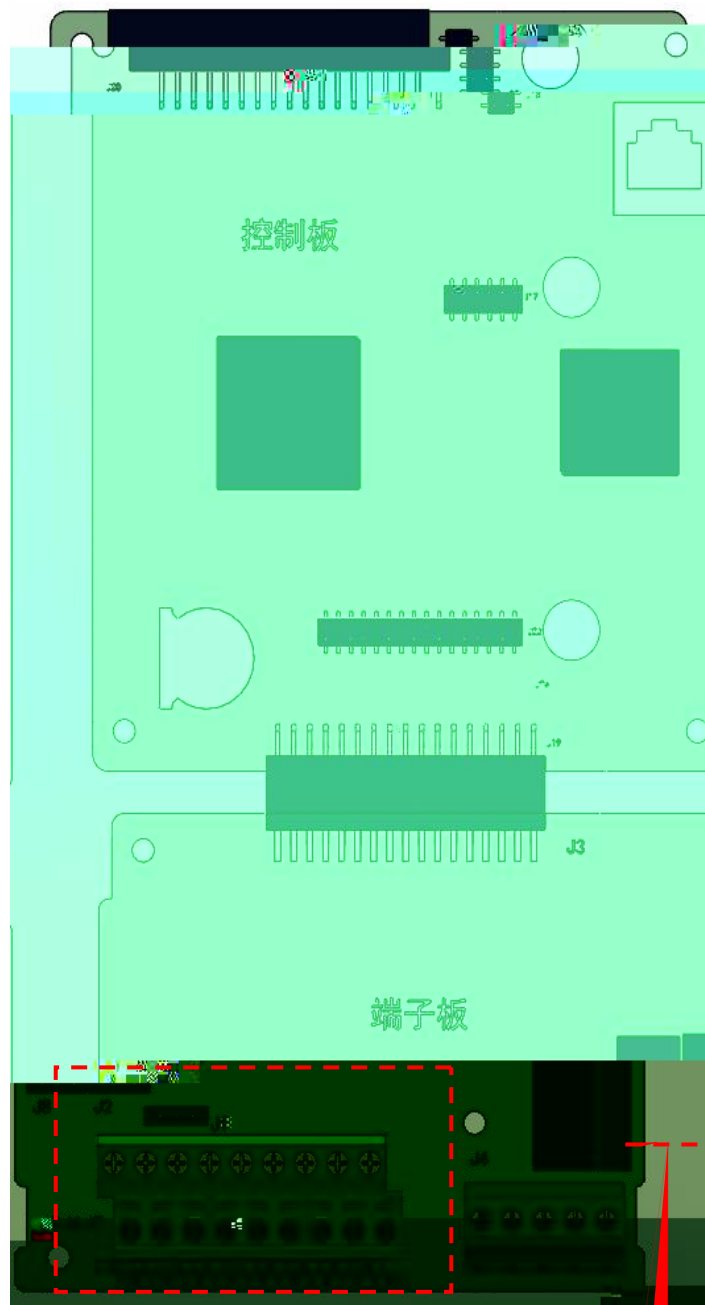

	+10V- GND	10V		+10V	50mA
	+24V- COM	24V		+24V	200mA
	PW		J2	24V	DI 1-DI 5 DO1 PW
	AI 1- GND	1		DC -10V~10V	100k
	AI 2- GND	2	J1	-10VDC~10VDC/0mA~20mA	100k 500
	DI 1- PW	1			
	DI 2- PW	2			
	DI 3- PW	3		9V~30V	DI 1- DI 4 3. 3k
	DI 4- PW	4	500Hz	DI 5	20KHz
	DI 5- PW	5			
	AO1- GND	1		J2	0V~10V 0mA~20mA
	AO2- GND	2		J8	0V~10V 0mA~20mA
	DO1- COM	1		0V~24V	0mA~50mA
	DO4A- DO4C	1		250VAC 3A	CCS =0.4
	DO4B- DO4C	2		30VDC 1A	
	DO5A- DO5C	3	Y2	250VAC 2A	CCS =0.4
				30VDC 1A	

2

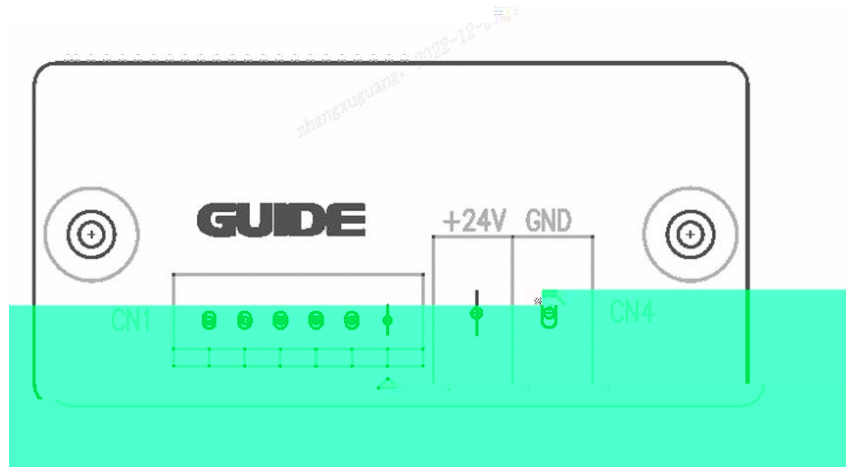

DC+24V	CN4	+24V- GND	
	CN1		L1/L2/L3

4.3

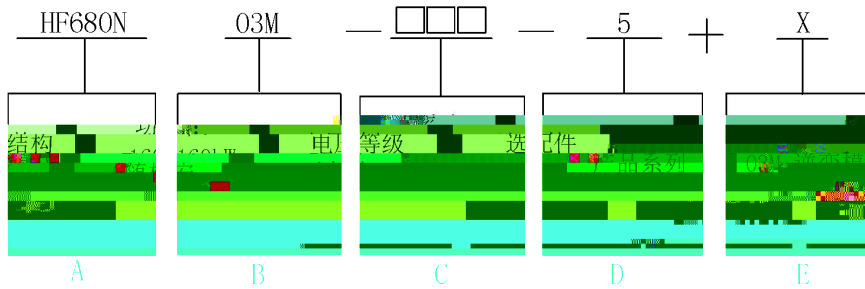

A	
B	O3M O3C
C	160 160kW 1000 1000kW
D	5 380V 5 500V
E	





4.5

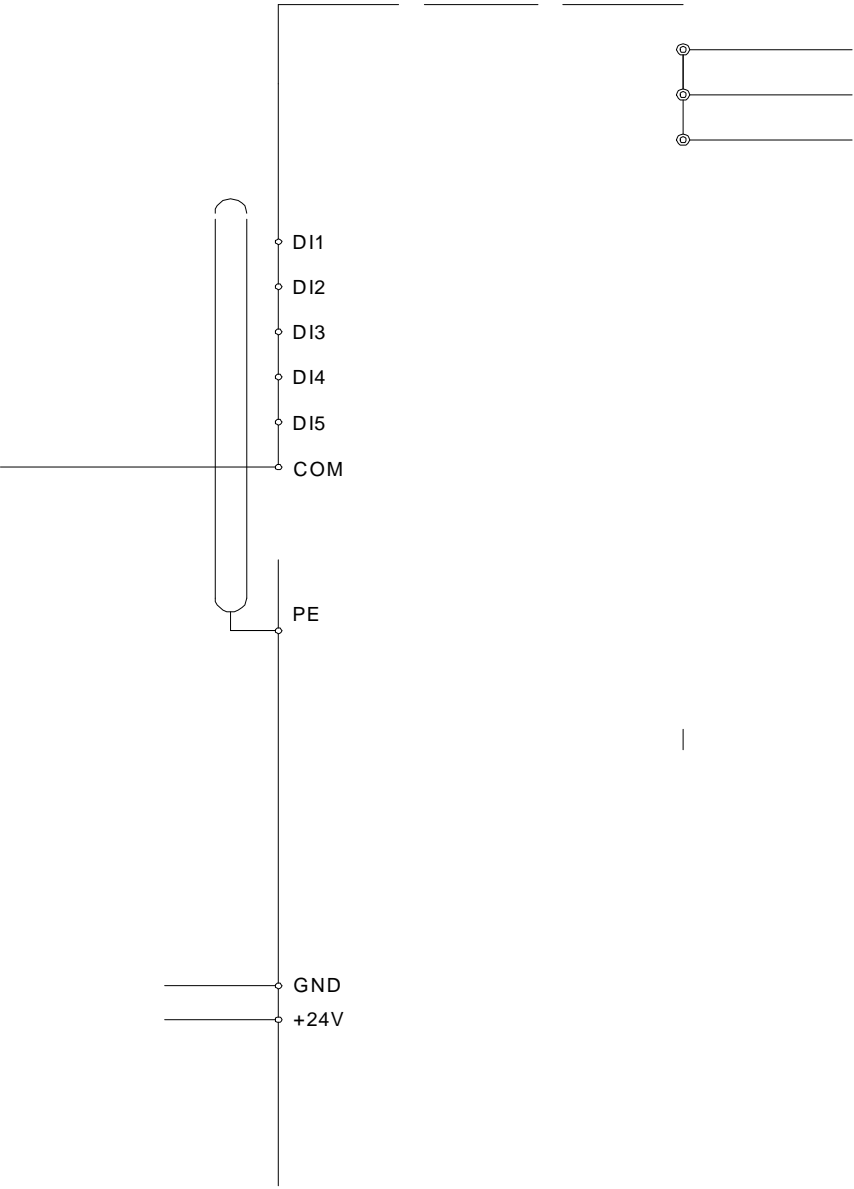

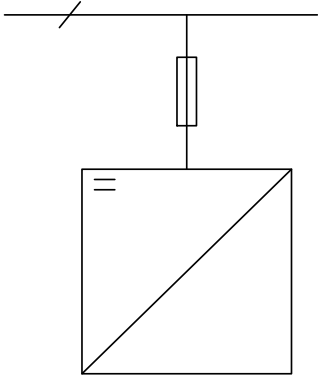

HF 680N03M 220- 5	120	498
HF 680N03M 250- 5	150	549
HF 680N03M 280- 5	70* 2	611
HF 680N03M 315- 5	70* 2	687
HF 680N03M 355- 5	90* 2	792
HF 680N03M 400- 5	120* 2	925
HF 680N03M 450- 5	150* 2	1055
HF 680N03M 500- 5	70* 4/185* 2	1160
HF 680N03M 560- 5	70* 4/185* 2	1270

1. 560kW

2.

HF 680N

4. 6

		540V 810V		
		(VC)	(SVC)	V/F
		Profibus DP		
		380V 500V		5%
		0 300Hz		
		0Hz/200%(VC SVC)	0.8Hz/150%(V/F)	
		1kHz 10kHz		
			150% 5	1
			180% 5	1

4.7

		kW			kW
HF680N03M045-5	B3	0.8	HF680N03M220-5	B5	4.2
HF680N03M055-5		1.0	HF680N03M250-5		4.8
HF680N03M075-5	B4	1.4	HF680N03M280-5	B6	5.6
HF680N03M090-5		1.7	HF680N03M315-5		6.3
HF680N03M110-5		2.1	HF680N03M355-5		7.1
HF680N03M132-5		2.5	HF680N03M400-5		8.0
HF680N03M160-5		3.0	HF680N03M450-5		9.0
HF680N03M185-5	B5	3.5	HF680N03M500-5		10.0
HF680N03M200-5		3.8	HF680N03M560-5		11.2

4.7

- (1) 200%
- (2) 50% HF680N
- (3) HF680N

5.

5.1

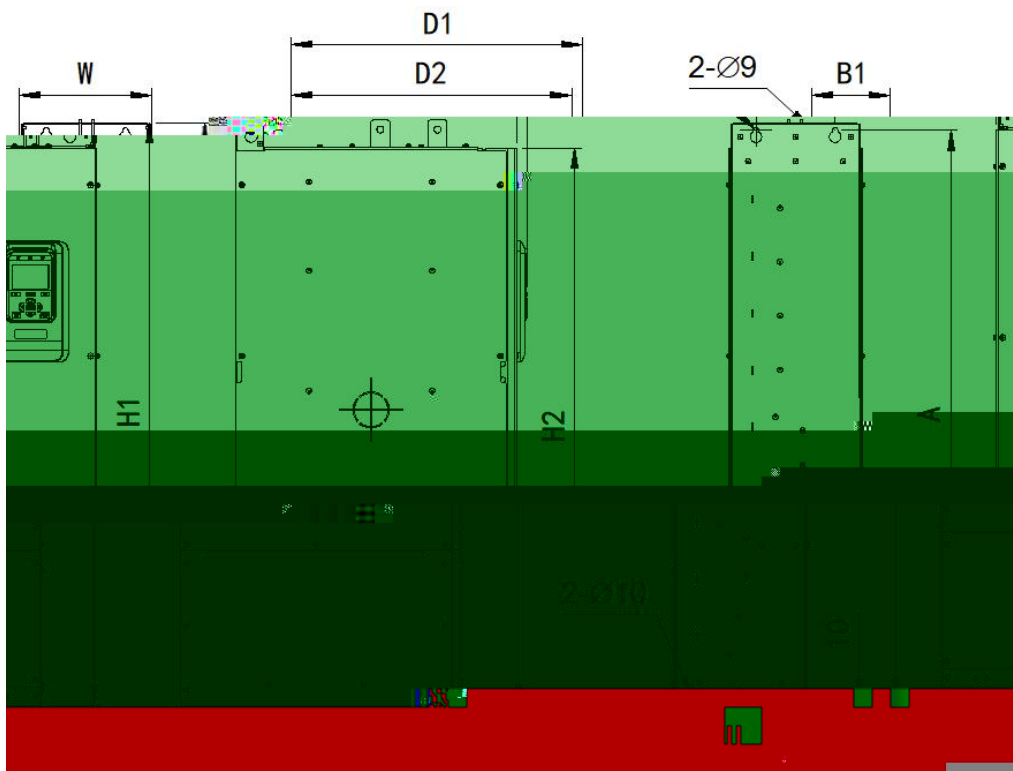

B4

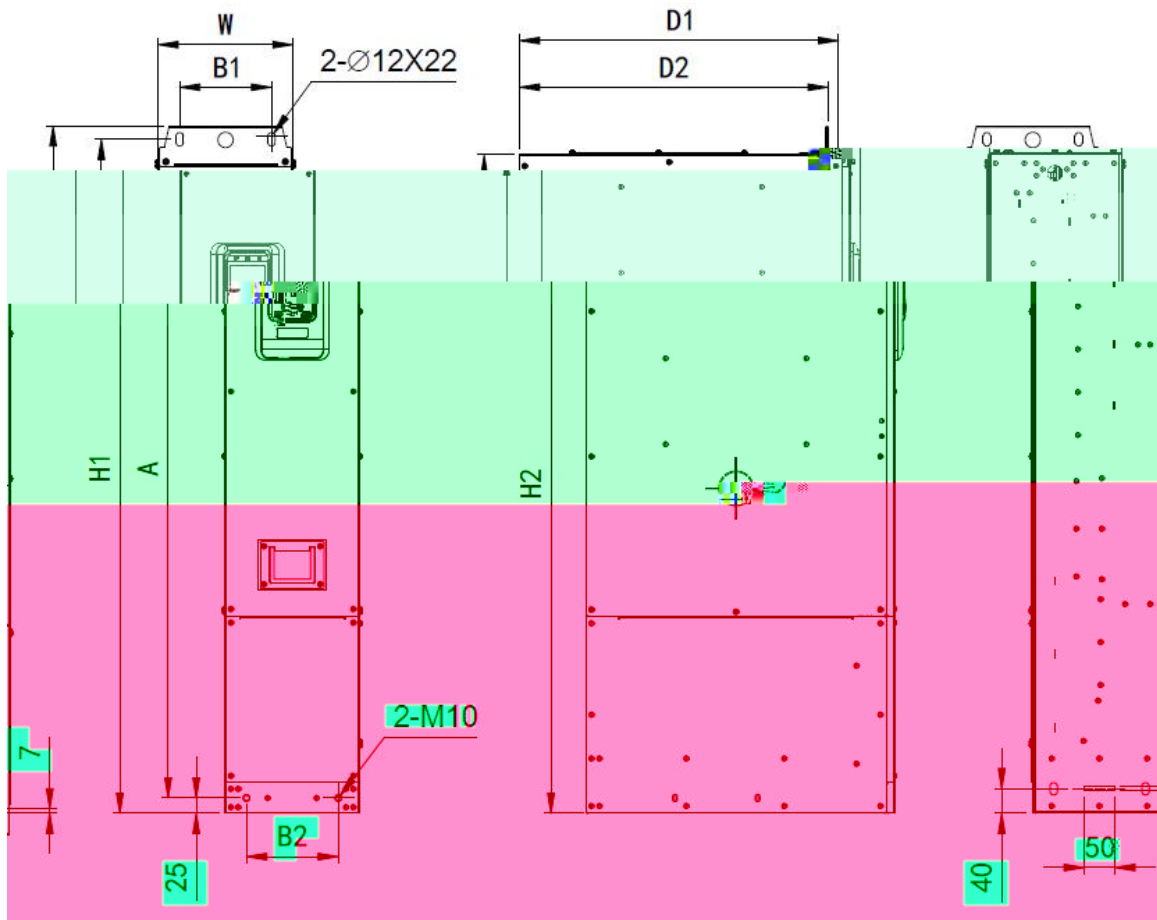

B5

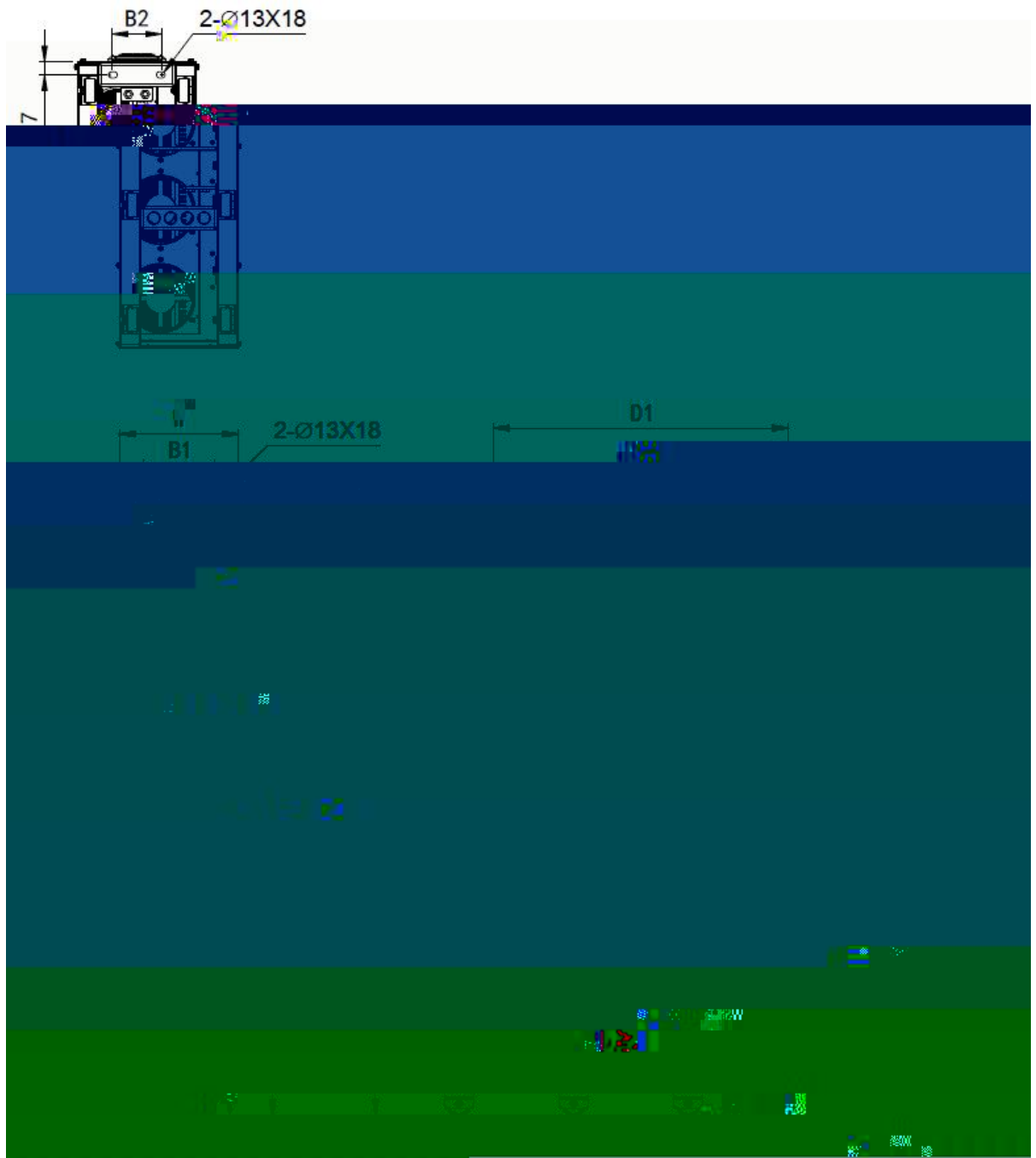

B6

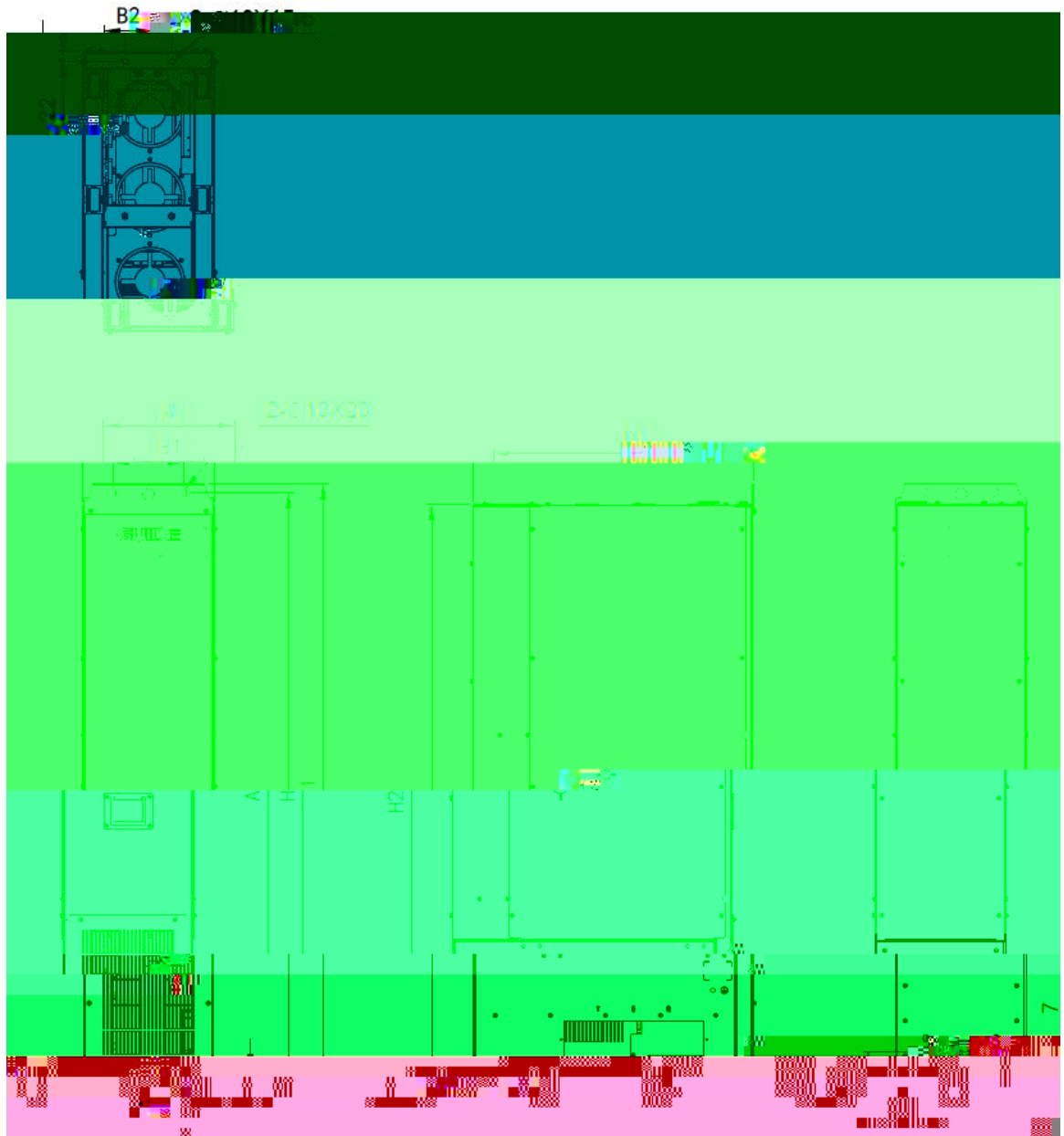

LCL

		mm					mm			8 8	kg
		H1	H2	W	D1	D2	A	B1	B2		
HF 680N02M 160- 5	B4	920	880	210	462	444	899	125	150	4- M8	55
HF 680N02M 220- 5	B5	1125	1075	220	520	505	1075	150	150	4- M10	80
HF 680N02M 315- 5	B6	1315	1268	250	618	600	1295	150	100	4- M2	120
HF 680N02M 355- 5											
HF 680N02M 400- 5											
HF 680N02M 450- 5											
HF 680N02M 500- 5											
HF 680N02M 560- 5											

5. 2

315kW-3200kW

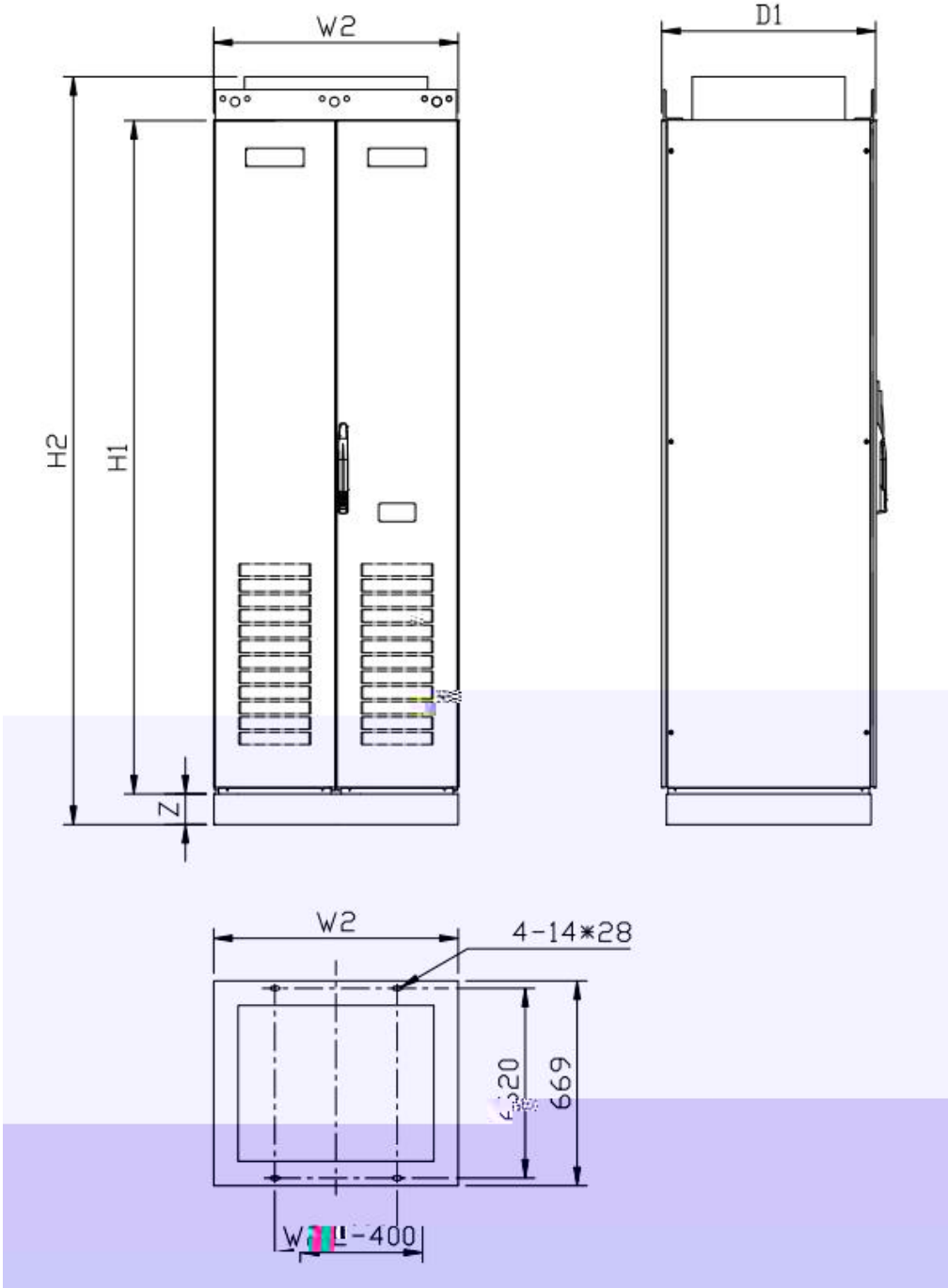

HF680N02C- 315- 5 HF680N02C- 400- 5 HF680N02C- 560- 5

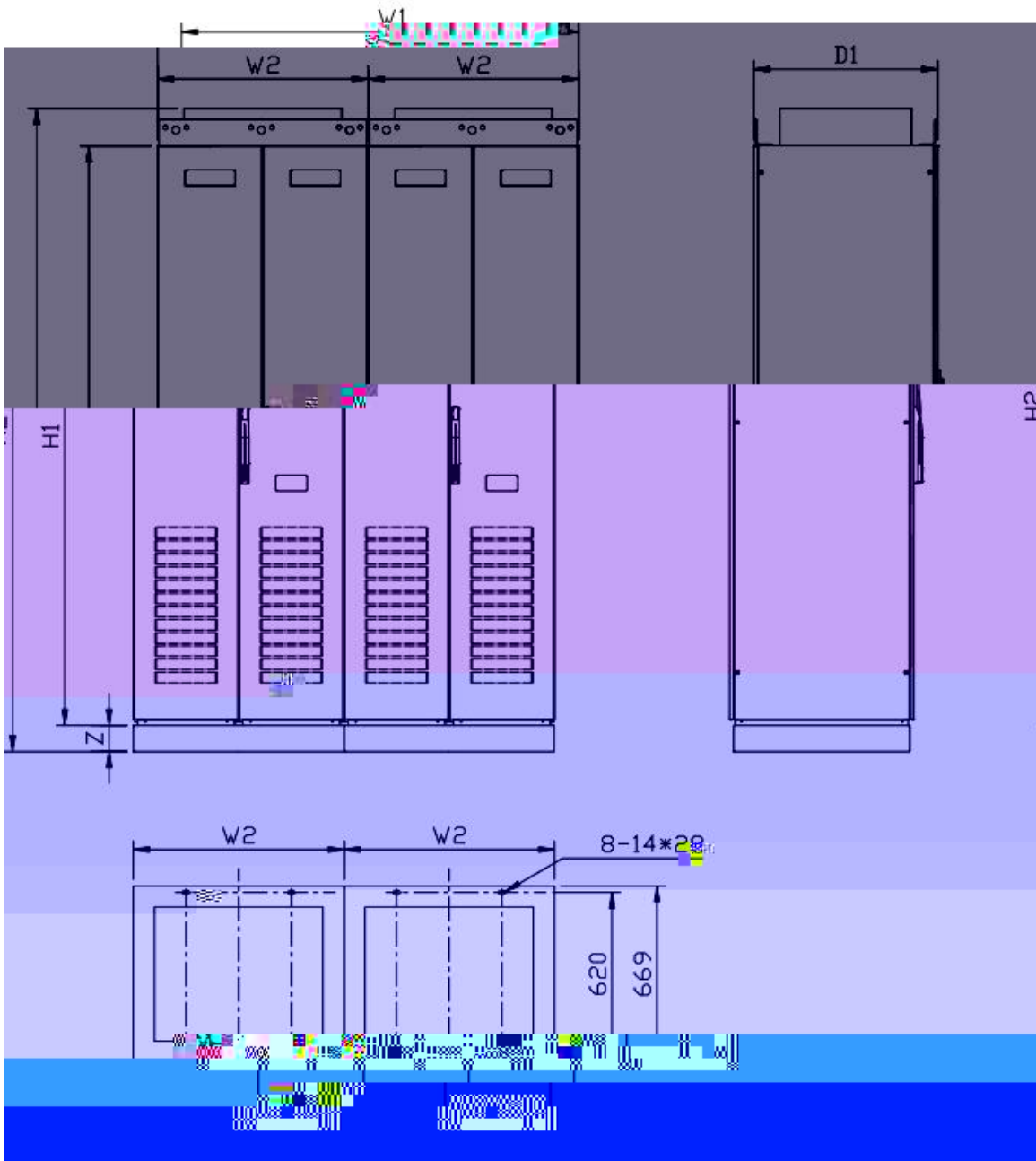

HF680N02C-800-5 HF680N02C-1000-5

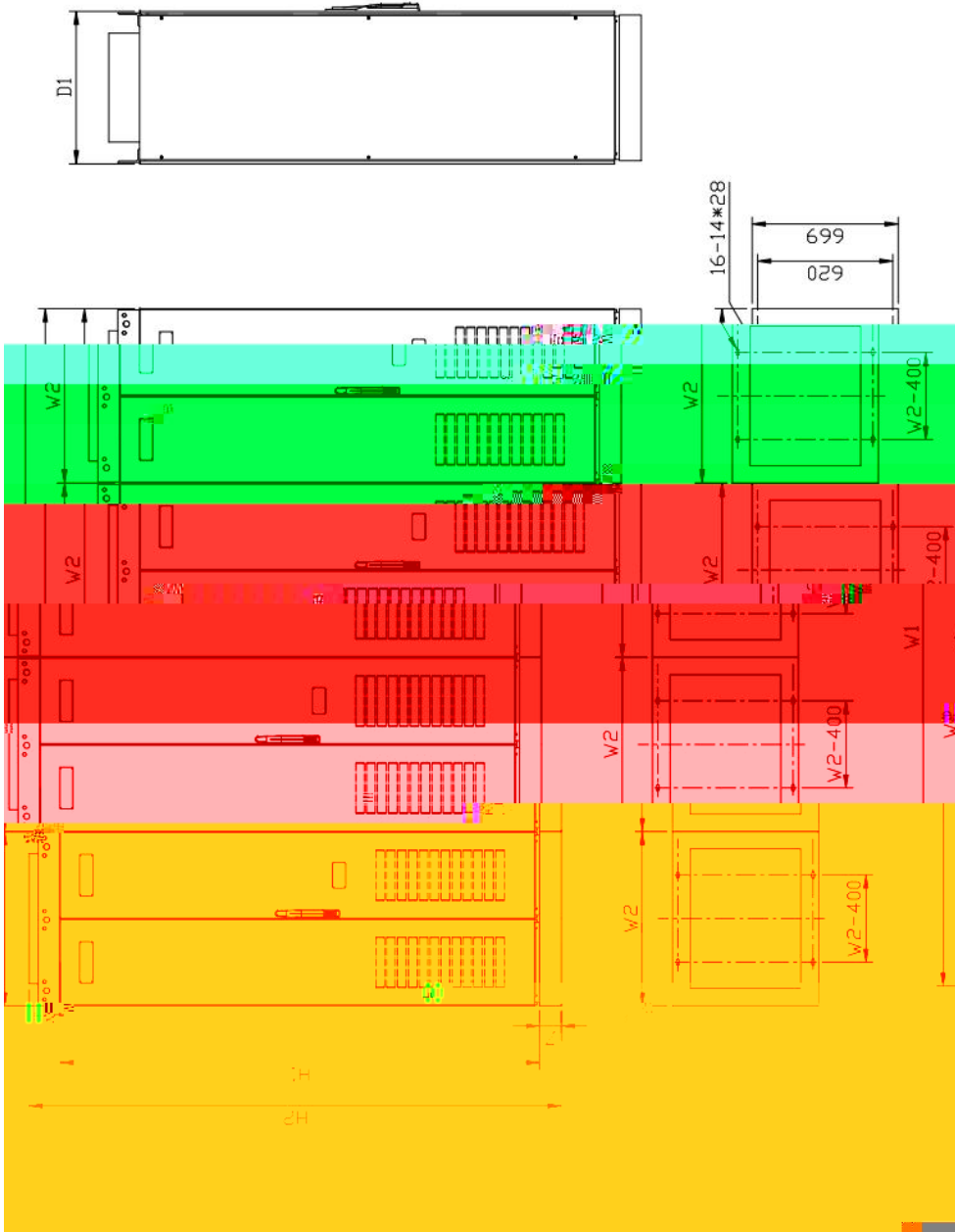

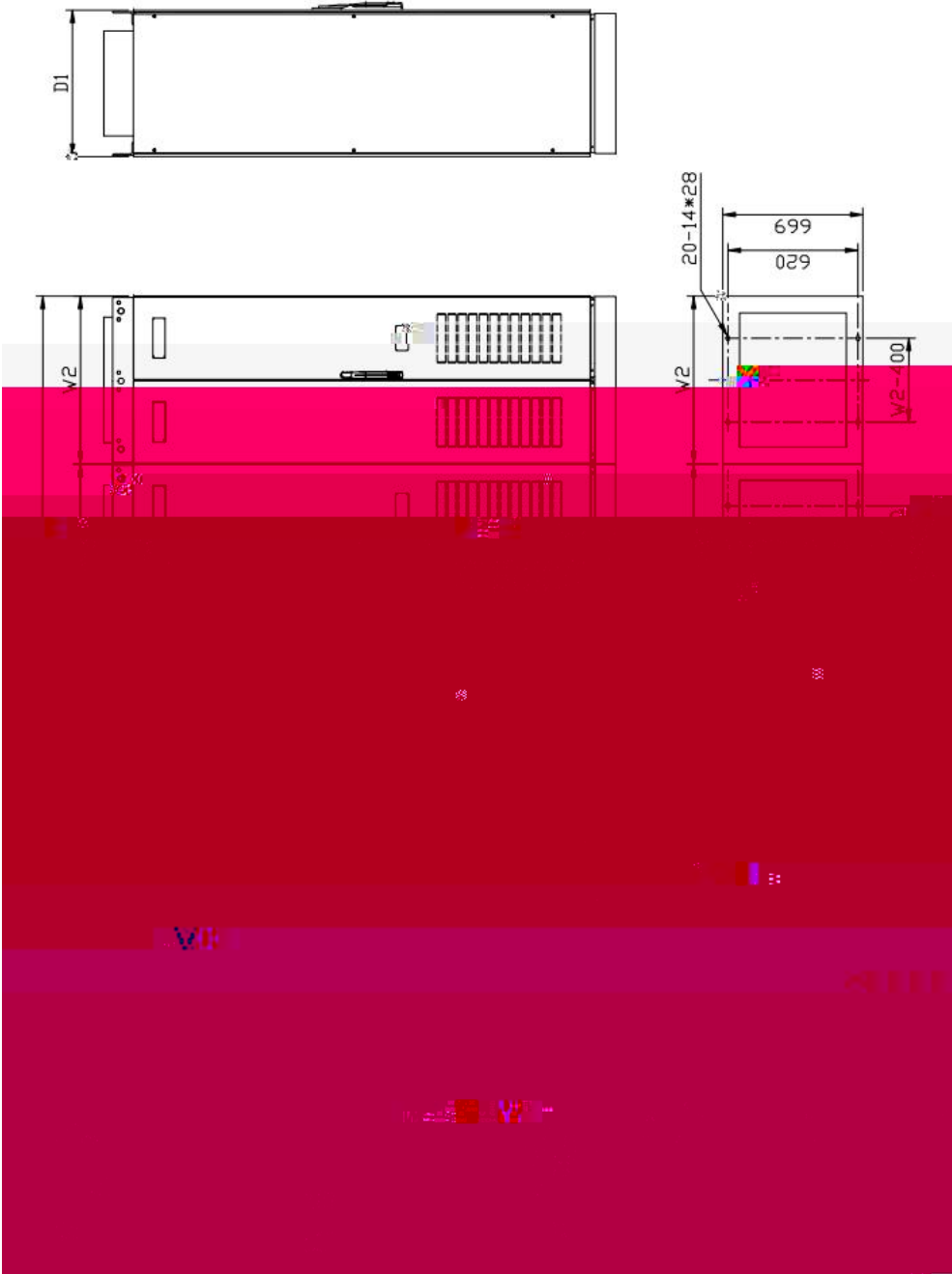

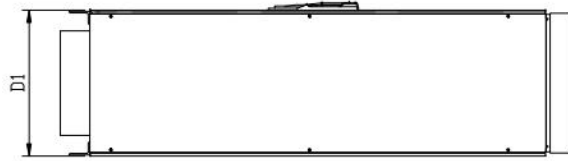

		mm						
		H1	H2	V1	V2	D1	Z	kg
4	HF680N02C- 800- 5+Z4	2200	2640	1600	800	700	300	1800
	HF680N02C- 1000- 5+Z4							

5.3

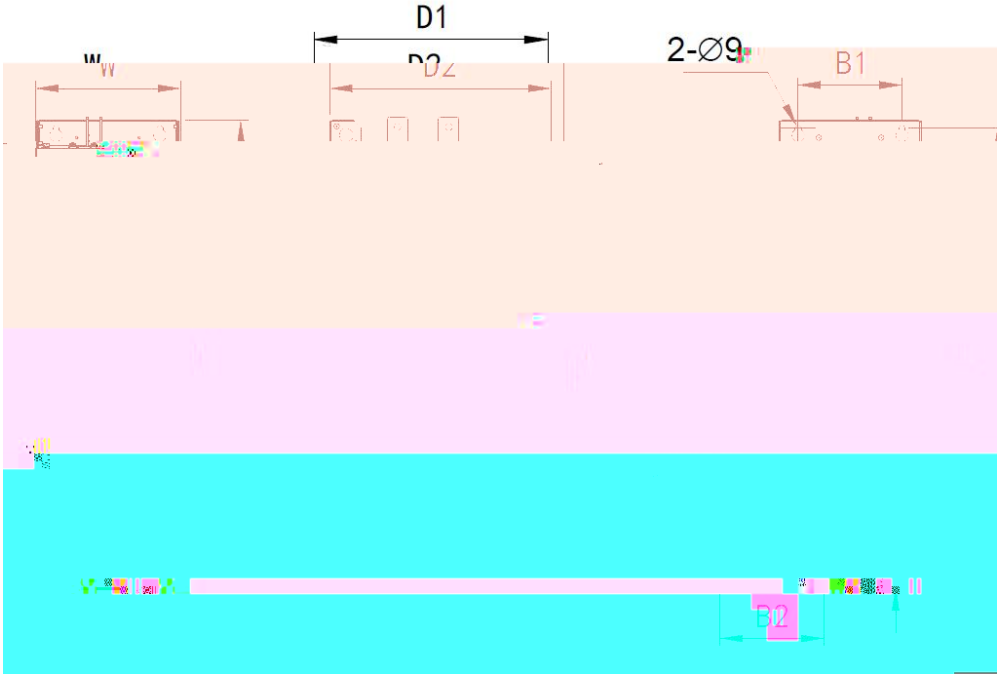

B3

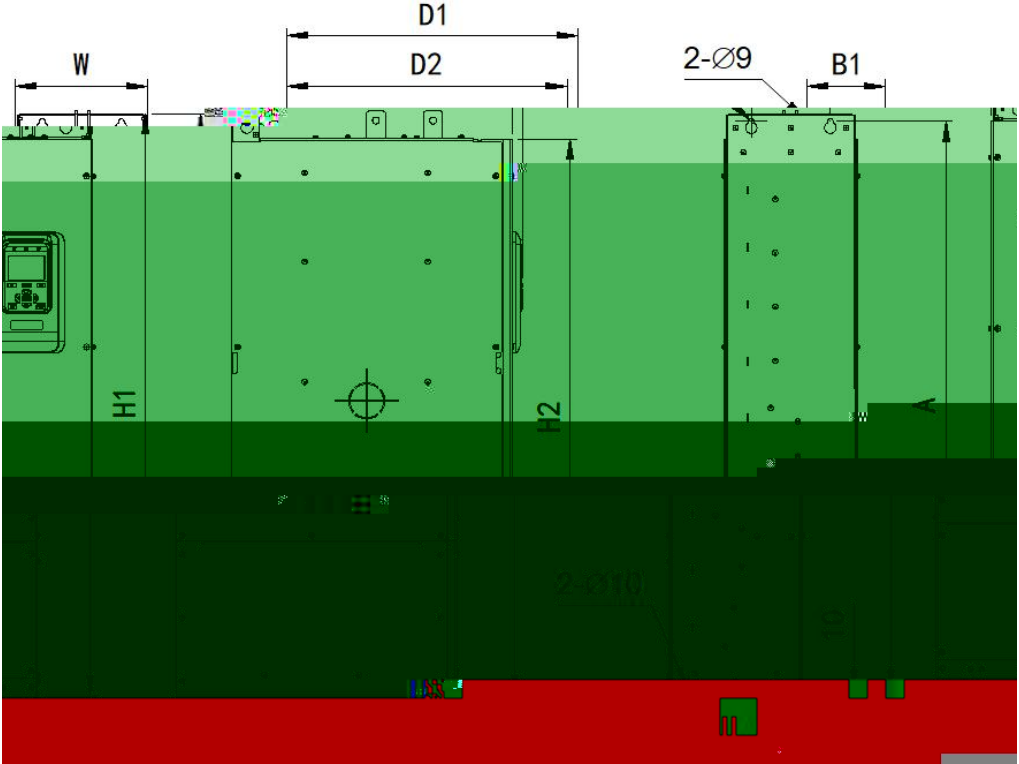

B4





		mm					mm			8.8	kg
		H1	H2	W	D1	D2	A	B1	B2		
HF 680N03M 045- 5	B3	673	633	210	337	320	652	150	150	4-M8	30
HF 680N03M 055- 5											
HF 680N03M 075- 5	B4	920	880	210	462	444	899	125	150	4-M8	55
HF 680N03M 090- 5											
HF 680N03M 110- 5											
HF 680N03M 132- 5											
HF 680N03M 160- 5											
HF 680N03M 200- 5	B5	1122	1075	221	522	505	1075	150	150	4-M10	80
HF 680N03M 220- 5											
HF 680N03M 250- 5											
HF 680N03M 280- 5											
HF 680N03M 315- 5	B6	1315	1268	250	618	600	1295	150	100	4-M12	120
HF 680N03M 355- 5											
HF 680N03M 400- 5											
HF 680N03M 450- 5											
HF 680N03M 500- 5											
HF 680N03M 560- 5											

5. 4

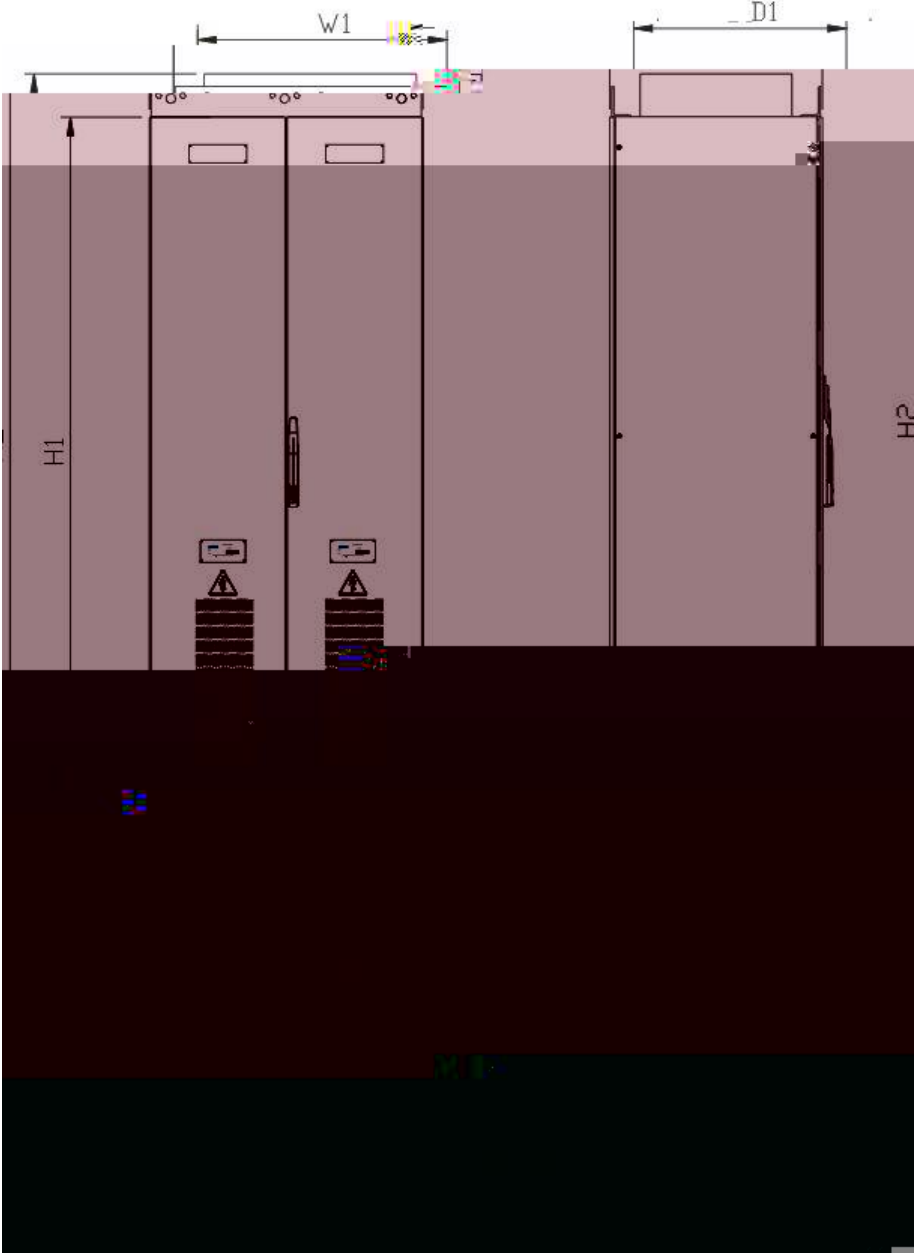

		mm					kg
		H1	H2	W1	D1	Z	
1	HF680N03C- 630- 5+Z1						
	HF680N03C- 710- 5+Z1						
	HF680N03C- 800- 5+Z1	2200	2440	800	700	100	900
	HF680N03C- 900- 5+Z1						
	HF680N03C- 1000- 5+Z1						
2	HF680N03C- 630- 5+Z2						
	HF680N03C- 710- 5+Z2						
	HF680N03C- 800- 5+Z2	2200	2540	800	700	200	900
	HF680N03C- 900- 5+Z2						
	HF680N03C- 1000+Z2						
3	HF680N03C- 630- 5+Z3						
	HF680N03C- 710- 5+Z3						
	HF680N03C- 800- 5+Z3	2200	2590	800	700	250	900
	HF680N03C- 900- 5+Z3						
	HF680N03C- 1000+Z3						
4	HF680N03C- 630- 5+Z4						
		2200	2640	800	700	300	

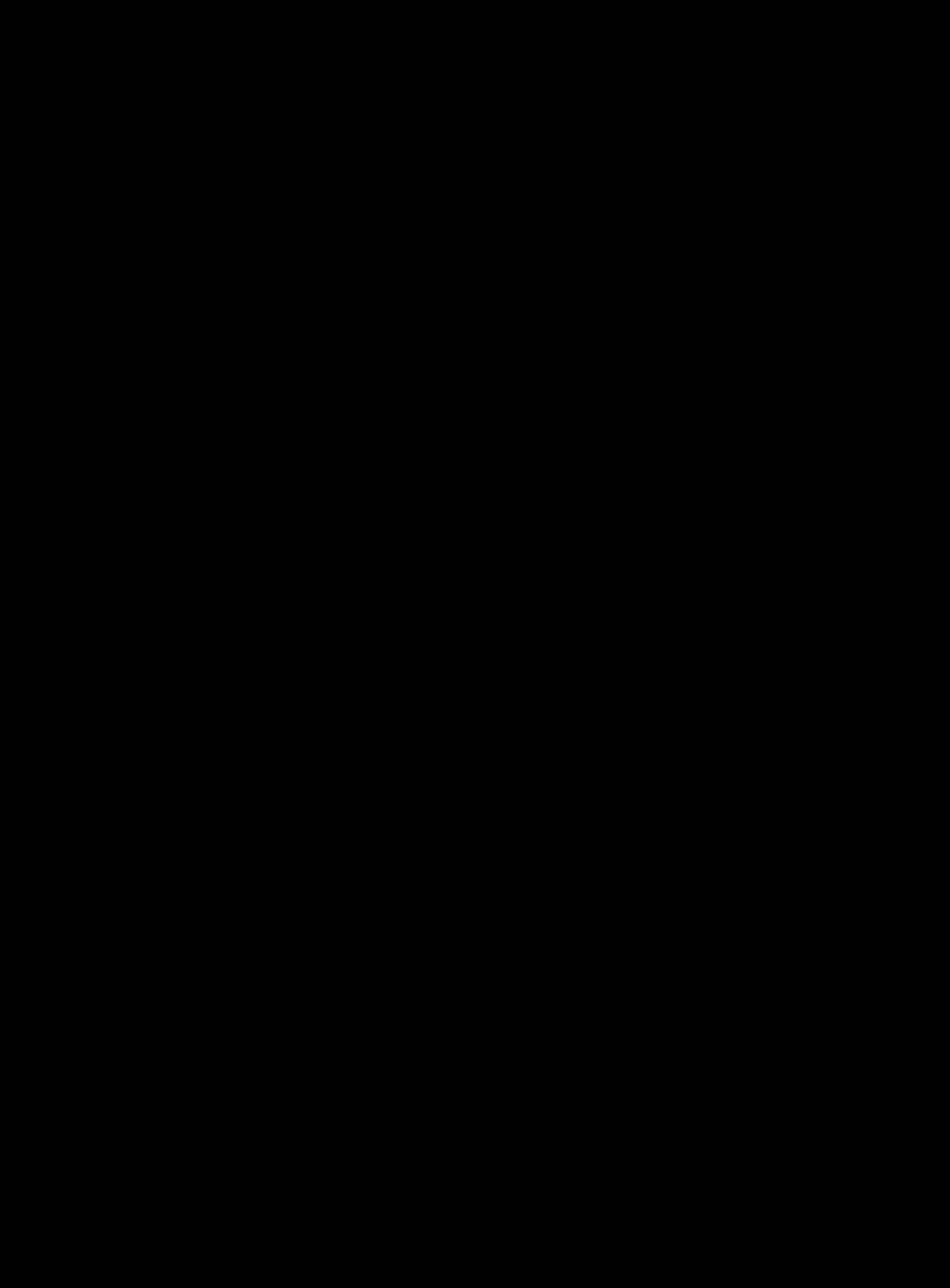

B&

	N N W E
--	---------------

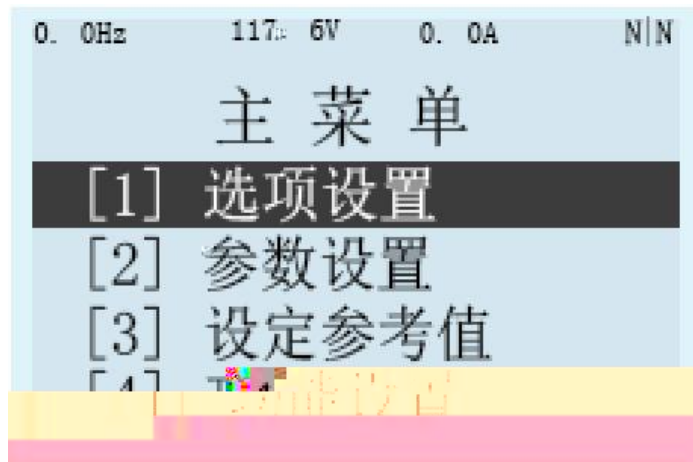

4

ENTER

F1/F2

6.4

- 1 Option Set
- 2

6.4.1

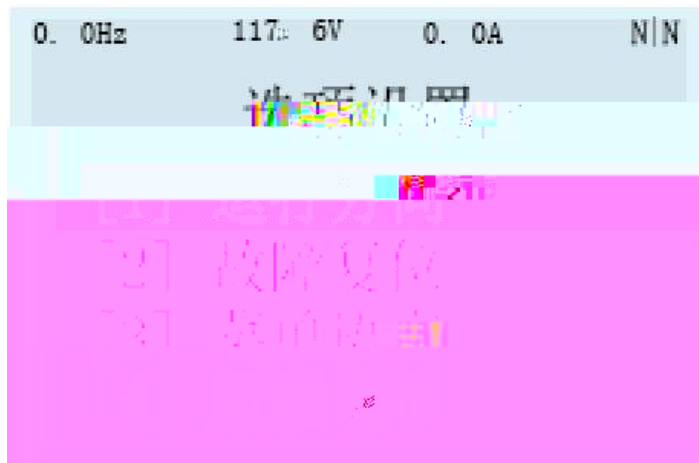

1	Choose Direction	
2	Reset Error	
3	Menu Language	
4	Monitor Setting	
5	LCD Contrast	
6	Time Setting	
7	Version	
8	OLD COM	



	Torque Limiter	[%]	%
	1 Anal og output1	[%]	1
	2 Anal og output2	[%]	2

6.4.4

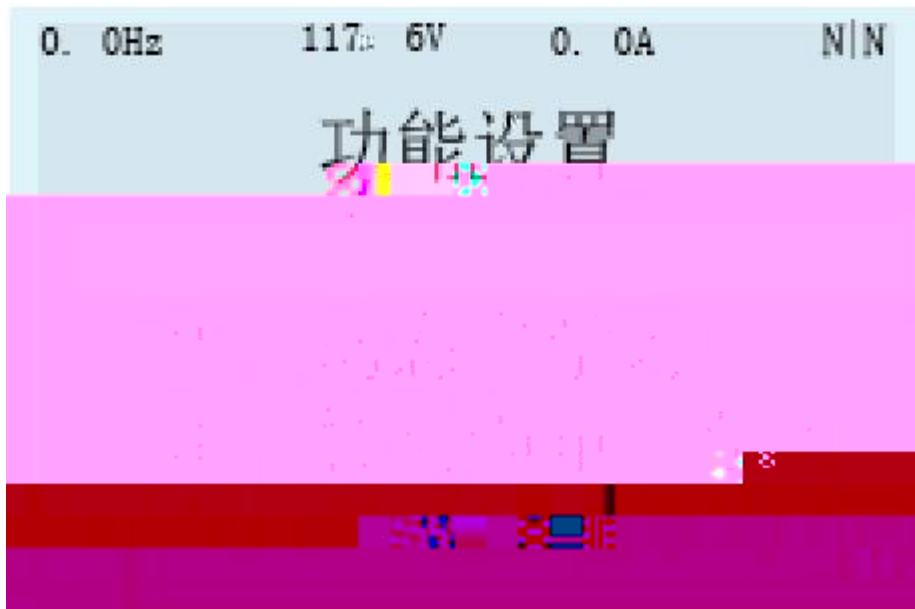

Function Setting

1	MotoTuning I	
2	MotoTuning II	

3	Moto Tuning III	
4	DC-Link Tuning (AFE)	AFE
5	Shortcut Paras Setting	
6	Parameter Initialization	
7	Delete Fault Records	
8	System Restart	
9	Backup Parameter	
10	Recover Parameter	
11	Compare Parameter	
12	Backup Para DSP DSP	DSP
13	Restore Para DSP DSP	DSP

1

2

5

“ Enter”

6.4.5

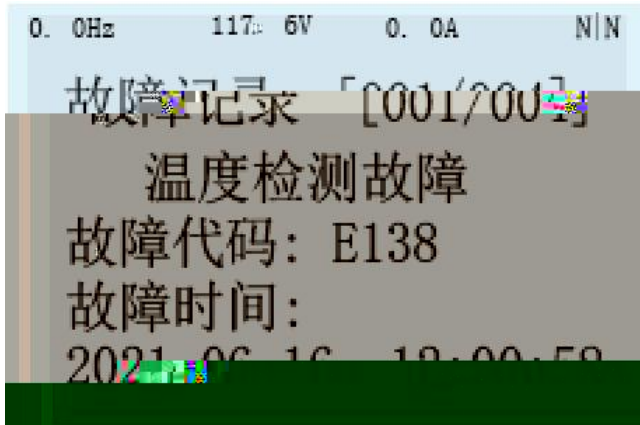

Fault Record

Access Permi ssi ons

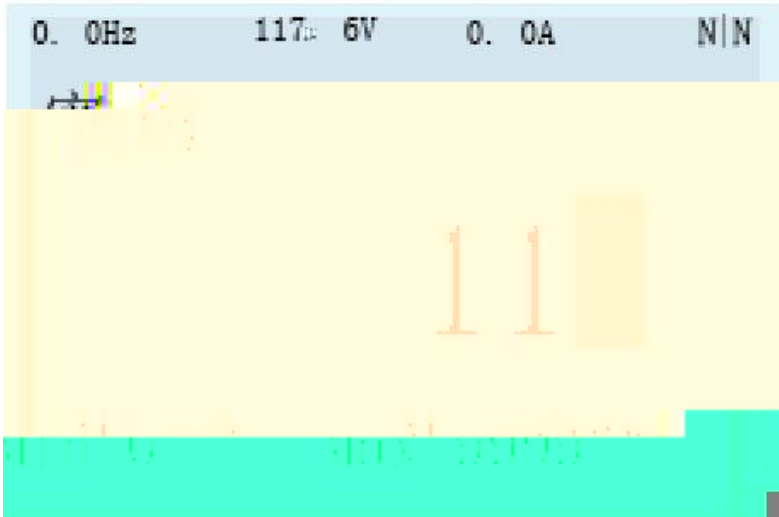

7.

7.1

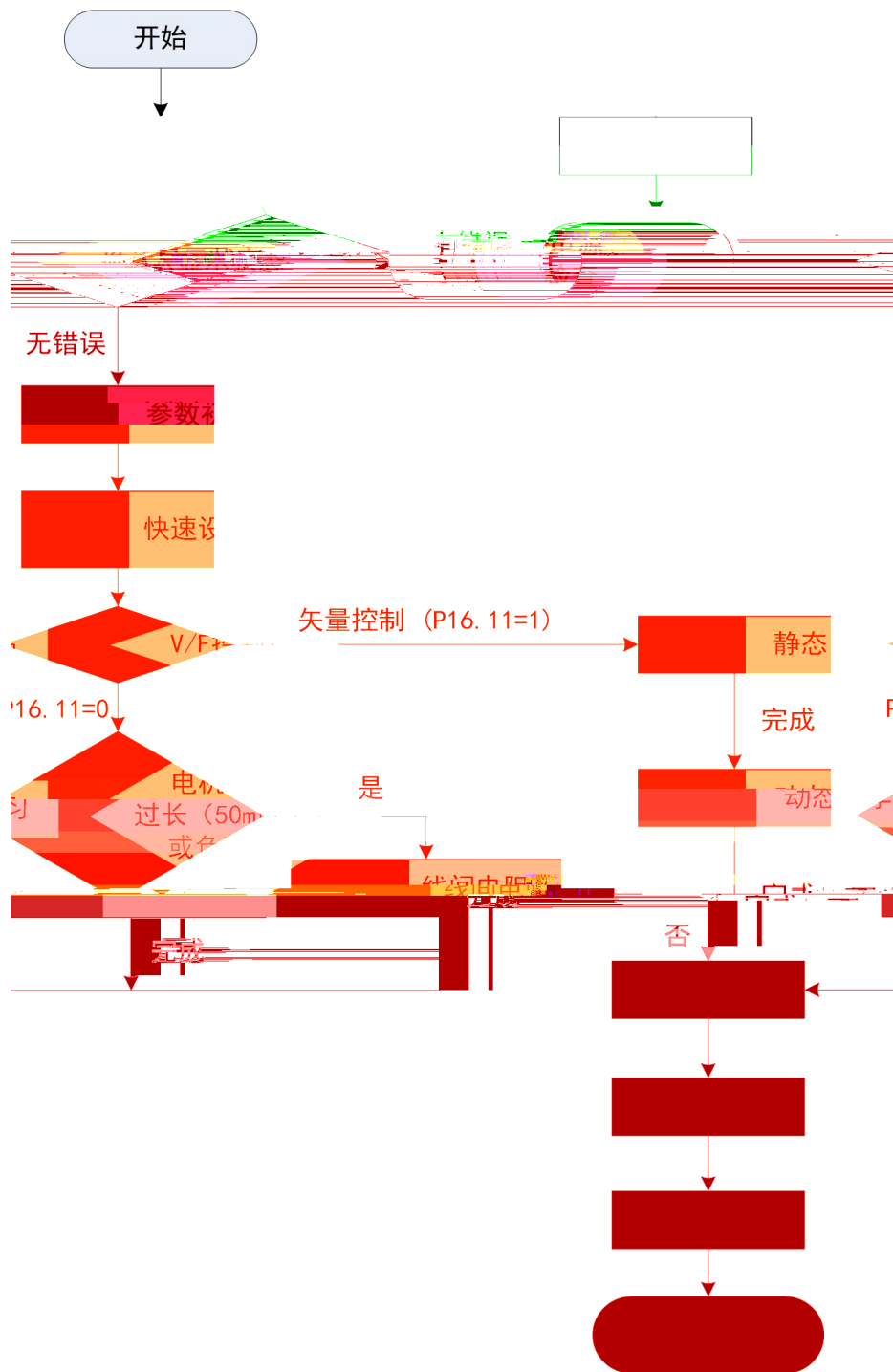

/

V/F P16. 11=0 V/F

P16. 11=2 P16. 11=1

7.2

1
2
3
4
5
6
7
8
9
10

AC380~500V 50/60Hz
U, V, W

PG PG

0. 0Hz	117. 6V	0. 0A	N N
电机速度 [Hz]: 0. 0Hz			
给定频率 [Hz]: 10. 0Hz			
母线电压		: 117. 6V	
电机电流		: 0. 0A	

Warning/Error

N | E

W | E

7.2.1

5.4 " "

7.2.2

P16.2			
P16.3			
P16.4			
P16.5			
P16.6			
P16.7		120× P16.5 / P16.6	
P16.9		120× P16.5/P16.7	
P16.11		[0] V/F [1] [2]	0
P16.14	V/F	[0] V/F [1] V/F [2]	0
P16.24		V/F	50 [Hz]
P8.16	1	P8.15	3
P8.35	1	P8.34	3
P8.0		[0] [1] [2] DP [3] MODBUS [4]	1

		[0] I/O	
		[1]	1
		[2]	2
P8.10		[3]	3
		[4] DP	
		[5] MODBUS	
		[6]	
P8.3		[0]	1
		[1]	
P7.0	[1]	0~	

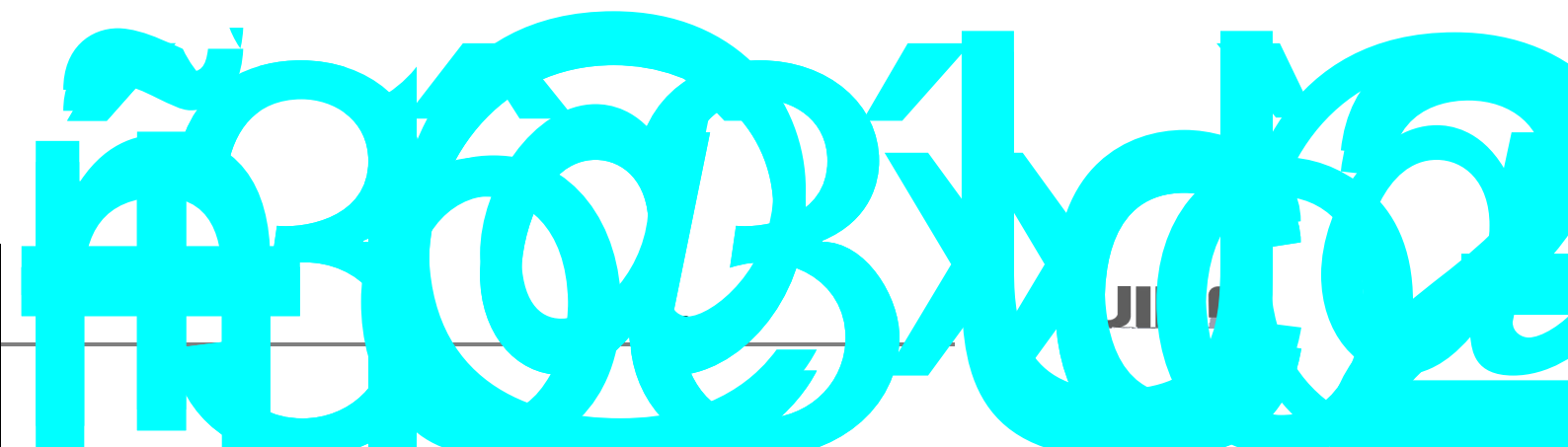

4

50%

7.2.4

HF680N

	7.5%
	50% 50%
	1/5
	P16
	V/F

7.2.7

1				
2		LOC/REM	LOCAL	LOCAL
3		ENTER	[1]	RUN
	RUN			5Hz

8.

8.1

8.1.1

DI 1

DI 2

DI 3: 14

DI 4

DO2

DO3:

DO4

DO

DO5

1

380V

220V

PO. 1

"

"

"

"

" DO4A"

" DO4C"

" DO5A"

" DO5C"

DO2

PLC

1

P3. 0- P3. 7

0

PLC

DI

"

"

"

H L"

DI

1

P3. 0	1	
P3. 1	20	
P3. 2	14	LCL
P3. 3	5	
P4. 1 DO2	2	
P4. 2 DO3	1	

P4. 3	DC	0	DO
P4. 4		32	
P7. 0		180%	
P7. 4		200%	
P7. 12	730V		430V 800V
P8. 6	300s		300s 0. 5s
P16. 0	380V		
P16. 2			400kW 400kW
P16. 4			400kW 640A
P16. 11	3		
P16. 12	3		3K
P24. 7	0V		ADJ

$$P16. 0 + P24. 7 = P16. 0$$

AFE " Stop

P8.6 0.5s Run A B C

Stop

P N P N Local /Remote

P16. 0	375V			580V
375V	P16. 0	400V		600V
400V	P16. 0	430V		630V
430V	P16. 0	450V		665V
450V	P16. 0	460V		680V
P16. 0	460V			700V
	620V		P16. 0	380V P24. 7
20V		620V		
380V			" / "	" "

D02

D04

D05

1

D0

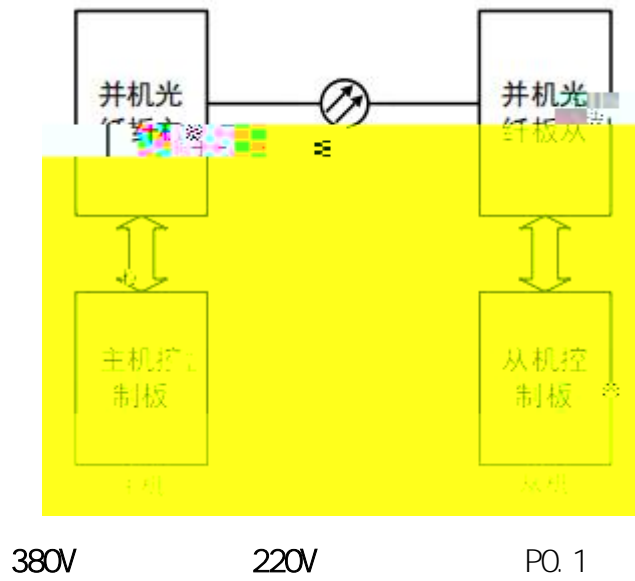

*

*

DI

DO

DO

" D04A"

" D04C"

" D05A"

" D05C"

P16. 0	380V		
P16. 2		1/2	800kW 400kW
P16. 4		1/2	800kW 608A
P16. 11	3		
P16. 12	3		3K

P2. 0	1		
P2. 3	1		
P3. 0	1		
P3. 1	20		
P3. 2	14	LCL	
P3. 3	5		
P4. 1 D02	2		
P4. 2 D03	1		
P4. 3 D04	0		DO
P4. 4 D05	32		
P7. 0	180%		
P7. 4	200%		
P7. 12	730V		430V 800V
P8. 6	300s		300s 0. 5s
P16. 0	380V		
P16. 2			800kW 800kW
P16. 4			800kW 1216A

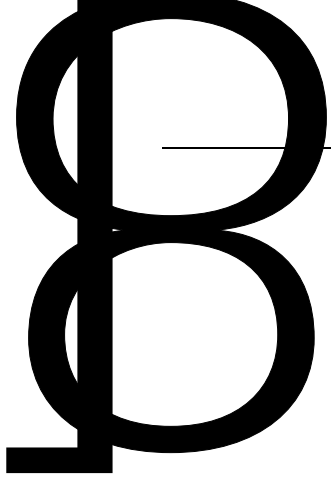

Local /Remote

Remote

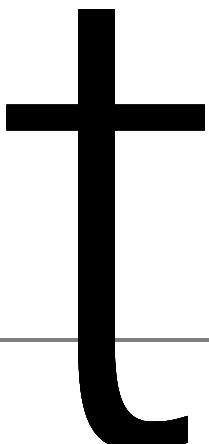

P3. 0- P3. 7

0

PLC

DI



DI

DI 1

参数	名称	16	13	12	11	10	9	8	7	6	5	4	3	2
101.5	数字量输入端子 [01 ~ 16]													
101.6	数字量输出端子 [01 ~ 16]													

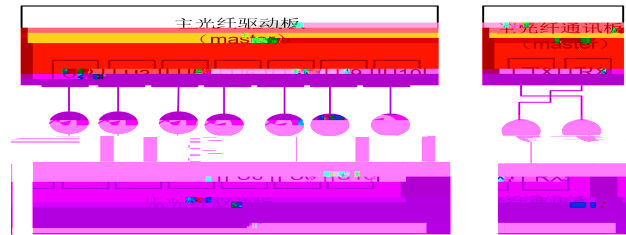

P2. 0	2		
P3. 2	14	LCL	
P4. 3 DO4	0	DO	
P4. 4 DO5	32		
P4. 1 DO2	2		
P7. 0	180%		
P7. 4	200%		
P7. 12	730V	800V	430V
P16. 0	380V		
P16. 2	1/2	800kW	400kW
P16. 4	1/2	800kW	608A
P16. 11	3		
P16. 12	3		3K

P2. 0	1		
-------	---	--	--

P2.3	1
P3.0	1
P3.1	20
P3.2	14
P3.3	5
P4.1 D02	2
	1
P4.3 D04	0
P4.4 D05	32
P7.0	180%
P7.4	200%
P7.12	730V
P8.6	300s
b	

LCL

DO



430V

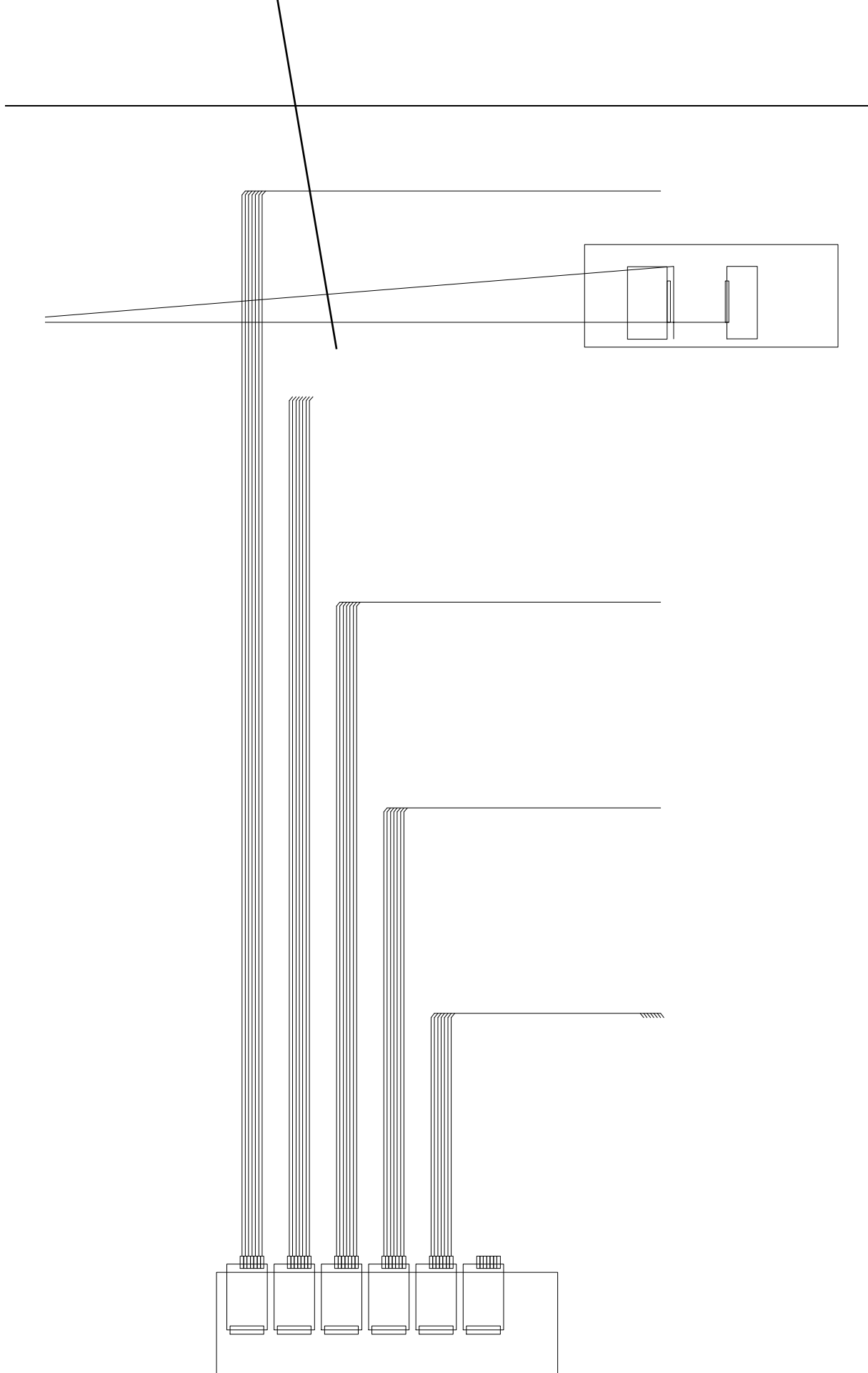

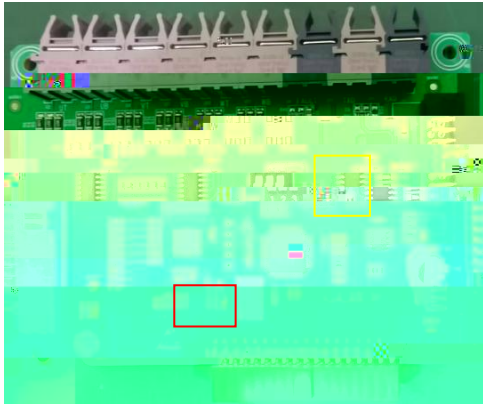

" "

PIN

PIN

DI1

DI2

DI4

DO2

DO4

DO5

DO

DI2

DO4

DO5

DO

PO.1

400KW

PO.1

1

" DO4A"

" DO4C"

1

1

" DO5A"

" DO5C"

1

P16.0 P24.7 =P16.0
+P24.7

620V P16.0 380V P24.7 20V
620V

101.2 [W1] 101.77 CAN
@ 101.80 CAN @ 0

"/ " " "

AFE 2s

IGBT 300s IGBT
103.31 49-51Hz

103.23 102.54 102.55
102.56

	A	B	C	
	102.54	102.55	102.56	
1	113.11	113.12	113.13	113.8
2	113.30	113.31	113.32	113.27
3	113.49	113.50	113.51	113.46

8.2

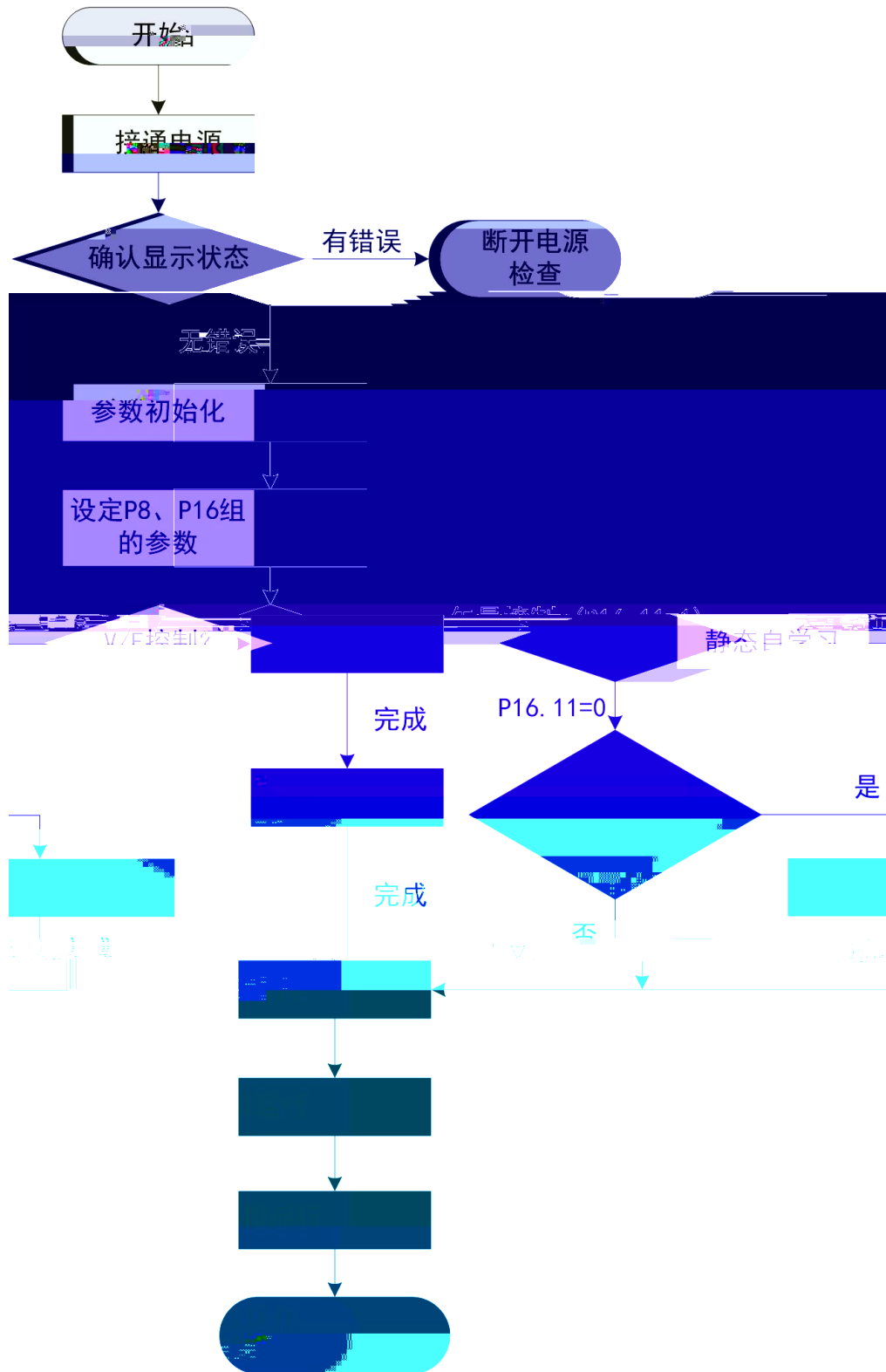



MT

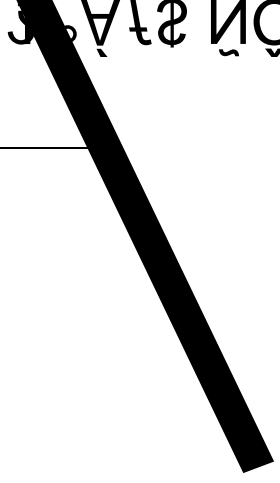

8.3.3

6

8.3.4

	[0]	
	[1]	
P8.0	[2] DP	1
	[3] MODBUS	
	[4]	
P8.3	[0]	1
	[1]	
P8.6	0 300s	0
P8.7		

P16. 1		80
P16. 2		
P16. 3		
P16. 4		
P16. 5		
P16. 6		
P16. 7		(120× P16. 5 / P16. 6)
P16. 9		(120× P16. 5 / P16. 7)
P16. 11		[0] V/F [1] [2]

8. 3. 5

5

P16. 11 [1] [2]
[0] V/F

6

V/F (P20. 74)
P20. 74

P20. 78 P20. 79 P20. 84

"

"

"

BO

"

"

"

"

50%

P20. 98

P20. 98

8. 3. 6

HF680N

7. 5%

5

0%

50%

1

2

1

2

8.3.9

9.

9.1

9.1.1

P2.0		[0] [1] [2]	0 2	0	500kW [0] 500kW [1] [2]
P2.2		[0] [1]	0 1	0	
P2.3			0 5	1	

9.1.2

P3.0	1	0 32	1
P3.1	2	0 32	2
P3.2	3	0 32	5





P8. 6			0. 00 300. 00 [s]	0. 00 [s]	1 GBT
-------	--	--	-------------------------	--------------	-------

9. 1. 6

P16. 0			320 550 [V]	500 [V]	
P16. 2			0. 0 4000. 0 [kW]	[kW]	
P16. 4			0. 0 6500. 0 [A]	[A]	
P16. 11		[0] V/F [1] [2] [3] [4]	0 4	0	[3]
P16. 12			3 8 [kHz]	3 [kHz]	3 8kHz

9. 1. 7 AFE

P24. 0		[0] [1] 1 [2] 2 [3] [4] DP [5] MODBUS [6]	0 6	0	AFE [0]
P24. 1	@		0 347	0	

		[0]				
		[1]	1			AFE
P24. 2		[2]	2	0 5	0	
		[3] DP				[0]
		[4] MODBUS				
		[5]				
P24. 3	@			0 347	0	
P24. 7	ADJ					

P24. 28			0 6500 [nF]	0[nF]	
P24. 29			0 6500 [nF]	0	AFE
P24. 30			0 6.5 [nF]	0	AFE

10.

10.1

P2

P2.0

[0]

[1]

2		
3		
4	. NC	
5		</RST
6	1 0	8.2
7	2 1	
8	3 2	
9	4 3	
10		
11		
12		
13	. NC	
14		
15	. NC	
16		
17	0	1 0 00
18	1	1 01 2 10 3 11 4
19		
20		AFE
21		
22	FUNC 22	
23	FUNC 23	
24		
25	FUNC 25	
26		
27	FUNC 27	
28		
29	FUNC 29	

10.3

P4

18	1	2
19	2	3
20	3	4
21	FUNC 21	0 3

1

5 5 0 U

GUIDE

114

10.4

P5

P5.0	AI 1	[0] [1] 0 +10V [2] -10 +10V [3] 0 20mA	0 3	1	
P5.1	AI 1	AI 1	0.0 1000.0 [ms]	25.0 [ms]	
P5.2	AI 1	AI 1	-10.00 10.00 [V]	0.000 [V]	
P5.3	AI 1	AI 1	-20.00 20.00 [mA]	0.000 [mA]	
P5.4	AI 1	AI 1	-10.00 10.00 [V]	0.000 [V]	
P5.5	AI 1	AI 1	0.00 20.00 [mA]	0.000 [mA]	
P5.6	AI 1	AI 1	-300.0 300.0 [%]	0.0 [%]	
P5.7	AI 1	AI 1	-10.00 10.00 [V]	10.000 [V]	
P5.8	AI 1	AI 1	0.00 20.00 [mA]	20.000 [mA]	
P5.9	AI 1	AI 1	-300.0 300.0 [%]	100.0 [%]	
P5.18	AI 2	[0] [1] 0 +10V [2] -10 +10V [3] 0 20mA	0 3	3	

		AI 2			
P5. 19	AI 2		0. 0 1000. 0 [ms]	25. 0 [ms]	
P5. 20	AI 2	AI 2	-10. 00 10. 00 [V]	0. 000 [V]	
P5. 21	AI 2	AI 2	-20. 00 20. 00 [mA]	0. 000 [mA]	
P5. 22	AI 2	AI 2	-10. 00 10. 00 [V]	0. 000 [V]	
P5. 23	AI 2	AI 2	0. 00 20. 00 [mA]	0. 000 [mA]	
P5. 24	AI 2	AI 2	-300. 0 300. 0 [%]	0. 0 [%]	
P5. 25	AI 2	AI 2	-10. 00 10. 00 [V]	10. 000 [V]	
P5. 26	AI 2	AI 2	0. 00 20. 00 [mA]	20. 000 [mA]	
P5. 27	AI 2	AI 2	-300. 0 300. 0 [%]	100. 0 [%]	

10.5

P6

P6.0	A01		7-1	0	14	2
P6.1			1	0	1000	0
P6.2	A01		A01	-300.0	300.0	0.0
					[%]	[%]
P6.3	A01		A01	-300.0		

P6. 21	AO2	AO2 (P6. 14 [13])	0. 0 100. 0 [%]	0. 0 [%]	
P6. 22	AO2	AO1	0. 0 1000. 0 [ms]	10. 0 [ms]	

7-1

- 0
- 1
- 2
- 3
- 4
- 5
- 6

10.6

P7

P7.0	[1]	1	0.0 300.0 [%]	180.0 [%]	
P7.1	[2]	2	0.0 300.0 [%]	180.0 [%]	
P7.2	[3]	3	0.0 300.0 [%]	180.0 [%]	
P7.3	[4]	4	0.0 300.0 [%]	180.0 [%]	
P7.4	[1]	1	0.0 300.0 [%]	235.0 [%]	
P7.5	[2]	2	0.0 300.0 [%]	235.0 [%]	
P7.6	[3]	3	0.0 300.0 [%]	235.0 [%]	
P7.7	[4]	4	0.0 300.0 [%]	235.0 [%]	
P7.8	[1]	1	0.0 100.0 [%]	20.0 [%]	
P7.9	[2]	2	0.0 100.0 [%]	20.0 [%]	
P7.10	[3]	3	0.0 100.0 [%]	20.0 [%]	
P7.11	[4]	4	0.0 100.0 [%]	20.0 [%]	
P7.12			600 920 [V]	900 [V]	
P7.13			300 500 [V]	350 [V]	
P7.14			60.0 100.0 []	87.5 []	
P7.15			50.0 100.0 []	80.0 []	
P7.19	[1]	1	100.0 720.0 [%]	120.0 [%]	
P7.20	[2]	2	100.0 720.0 [%]	120.0 [%]	
P7.21	[3]	3	100.0 720.0 [%]	120.0 [%]	

P7. 22	[4]	4	100.0	720.0	120.0
			[%		[%
P7. 23	1 M	1	0.00	3.00	0.50
			[s]		[s]
P7. 24	1 M2	2	0.00	3.00	0.50
			[s]		[s]
P7. 25	1 M3	3	0.00	3.00	0.50
			[s]		[s]
P7. 26	1 M4	4	0.00	3.00	0.50
			[s]		[s]
P7. 27	1	1	0.00	3.00	2.00
			[s]		[s]
P7. 28	2	2	0.00	3.00	2.00
			[s]		[s]

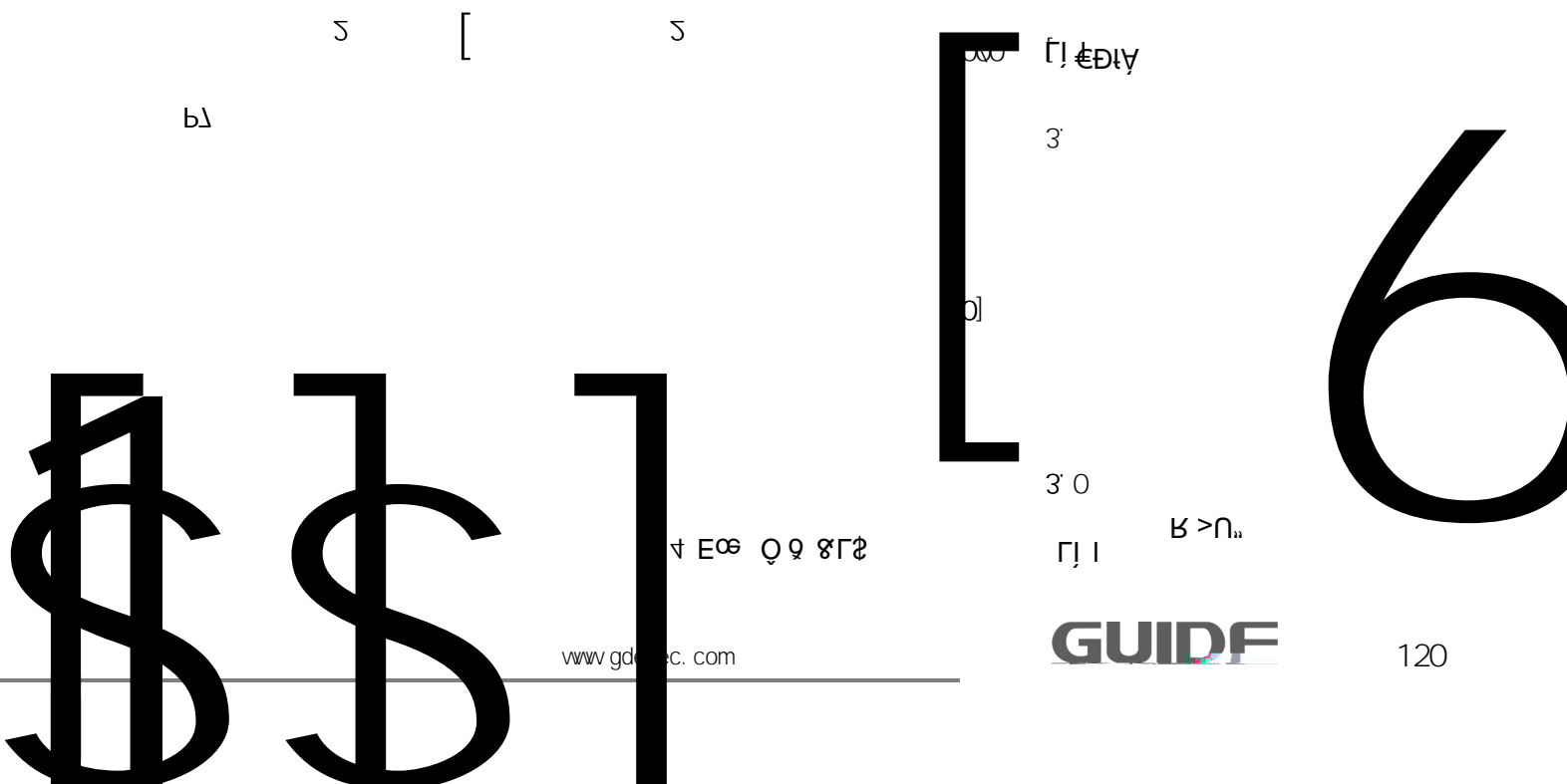





P8. 37	2	P8. 34	P8. 36	0.0 300.0 [s]	4.00 [s]
P8. 38	3			0.0 300.0 [%]	240.0 [%]
P8. 39	3	P8. 36	P8. 38	0.0 300.0 [s]	7.00 [s]
P8. 40	4			0.0 300.0 [%]	300.0 [%]
	4	P8. 38	P8. 40	0.0 300.0 [s]	

8 3

b8

b



[0

[0

[0

10.8

2

P9

P9.0		[0] [1] [2] DP [3] MODBUS [4]	0 4	0	
P9.1					
P9.2					
P9.3		[0] [1]	0 1	0	
P9.6			0.00 300.00 [s]	0.00 [s]	
P9.7			0.00 300.00 [s]	0.00 [s]	
P9.10		[0] I/O [1] 1 [2] 2 [3] [4] DP [5] MODBUS [6]	0 6	0	
P9.11					
P9.13		[0] [1] PROFIBUS [2] MODBUS [3]	0 3	0	
P9.14			0.1 10.0	1.0	
P9.15	1		0.0 300.0 [%]	100.0 [%]	
P9.16	1	P9.15	0.0 300.0 [s]	3.00 [s]	
P9.17	2		0.0 300.0 [%]	200.0 [%]	

P9. 18	2	P9. 15	P9. 17	0.0 300.0 [s]	4.00 [s]	
P9. 19	3			0.0 300.0 [%]	240.0 [%]	
P9. 20	3	P9. 17	P9. 19	0.0 300.0 [s]	7.00 [s]	
P9. 21	4			0.0 300.0 [%]	300.0 [%]	
P9. 22	4	P9. 19	P9. 21	0.0 300.0 [s]	10.00 [s]	
P9. 23	5			0.0 300.0 [%]	300.0 [%]	
P9. 24	5	P9. 21	P9. 23	0.0 300.0 [s]	10.00 [s]	
P9. 25	6			0.0 300.0 [%]	300.0 [%]	
P9. 26	6	P9. 23	P9. 25	0.0 300.0 [s]	10.00 [s]	
P9. 27	7			0.0 300.0 [%]	300.0 [%]	
P9. 28	7	P9. 25	P9. 27	0.0 300.0 [s]	10.00 [s]	
P9. 29	8			0.0 300.0 [%]	300.0 [%]	
P9. 30	8	P9. 27	P9. 29	0.0 300.0 [s]	10.00 [s]	
P9. 32		[0] [1] PROFIBUS [2] MODBUS [3]		0 3	0	
P9. 33				0.1 10.0	1.0	
P9. 34	1			0.0 300.0 [%]	100.0 [%]	
P9. 35	1	P9. 34		0.0 300.0 [s]	3.00 [s]	
P9. 36	2			0.0 300.0 [%]	200.0 [%]	

P10. 18	2	P10. 15	P10. 17	0. 0 300. 0 [s]	4. 00 [s]	
P10. 19	3			0. 0 300. 0 [%]	240. 0 [%]	
P10. 20	3	P10. 17	P10. 19	0. 0 300. 0 [s]	7. 00 [s]	
P10. 21	4			0. 0 300. 0 [%]	300. 0 [%]	
P10. 22	4	P10. 19	P10. 21	0. 0 300. 0 [s]	10. 00 [s]	
P10. 23	5			0. 0 300. 0 [%]	300. 0 [%]	
P10. 24	5	P10. 21	P10. 23	0. 0 300. 0 [s]	10. 00 [s]	
P10. 25	6			0. 0 300. 0 [%]	300. 0 [%]	
P10. 26	6	P10. 23	P10. 25	0. 0 300. 0 [s]	10. 00 [s]	
P10. 27	7			0. 0 300. 0 [%]	300. 0 [%]	
P10. 28	7	P10. 25	P10. 27	0. 0 300. 0 [s]	10. 00 [s]	
P10. 29	8			0. 0 300. 0 [%]	300. 0 [%]	
P10. 30	8	P10. 27	P10. 29	0. 0 300. 0 [s]	10. 00 [s]	
P10. 32		[0] [1] PROFIBUS [2] MODBUS [3]		0 3	0	
P10. 33				0. 1 10. 0	1. 0	
P10. 34	1			0. 0 300. 0 [%]	100. 0 [%]	
P10. 35	1	P10. 34		0. 0 300. 0 [s]	3. 00 [s]	
P10. 36	2			0. 0 300. 0 [%]	200. 0 [%]	

P10. 37	2	P10. 34	P10. 36	0. 0 300. 0 [s]	4. 00 [s]	
P10. 38	3			0. 0 300. 0 [%]	240. 0 [%]	
P10. 39	3	P10. 36	P10. 38	0. 0 300. 0 [s]	7. 00 [s]	
P10. 40	4			0. 0 300. 0 [%]	300. 0 [%]	
P10. 41	4	P10. 38	P10. 40	0. 0 300. 0 [s]	10. 00 [s]	
P10. 42	5			0. 0 300. 0 [%]	300. 0 [%]	
P10. 43	5	P10. 40	P10. 42	0. 0 300. 0 [s]	10. 00 [s]	
P10. 44	6			0. 0 300. 0 [%]	300. 0 [%]	
P10. 45	6	P10. 42	P10. 44	0. 0 300. 0 [s]	10. 00 [s]	
P10. 46	7			0. 0 300. 0 [%]	300. 0 [%]	
P10. 47	7	P10. 44	P10. 46	0. 0 300. 0 [s]	10. 00 [s]	
P10. 48	8			0. 0 300. 0 [%]	300. 0 [%]	
P10. 49	8	P10. 46	P10. 48	0. 0 300. 0 [s]	10. 00 [s]	
P10. 54				0. 0 300. 0 [%]	0. 0 [%]	
P10. 55		[0] [1]		0 1	0	
P10. 56				0. 00 300. 00 [s]	3. 00 [s]	
P10. 57		[0] [1]		0 1	1	
P10. 58				0. 00 300. 00 [s]	1. 50 [s]	

10.10

4

P11

P11. 0		[0] [1] [2] DP [3] MODBUS [4]	0 4	0	
P11. 1					
P11. 2					
P11. 3		[0] [1]	0 1	0	
P11. 6			0.00 300.00 [s]	0.00 [s]	
P11. 7			0.00 300.00 [s]	0.00 [s]	
P11. 10		[0] I/O [1] 1 [2] 2 [3] [4] DP [5] MODBUS [6]	0 6	0	
P11. 11					
P11. 13		[0] [1] PROFIBUS [2] MODBUS [3]	0 3	0	
P11. 14			0.1 10.0	1.0	
P11. 15	1		0.0 300.0 [%]	100.0 [%]	
P11. 16	1	P11. 15	0.0 300.0 [s]	3.00 [s]	
P11. 17	2		0.0 300.0 [%]	200.0 [%]	



10.11

1

P12

P12.0

[0]

0 1

1

[1]

[0] [%

P12.1

[1] [Hz]

0 2

1

[2] [rpm]

P12.2

1

0.0 3000.0 10.0

P12.3

2

0.0 3000.0 20.0

P12.4

3

0.0 3000.0 35.0

P12.5

4

0.0 3000.0 50.0

P12.6

5

0.0 3000.0 50.0

P12.7

6

0.0 3000.0 50.0

P12.8

7

0.0 3000.0 50.0

P12.9

8

0.0 3000.0 50.0

P12.10

9

0.0 3000.0 50.0

P12.11

10

0.0 3000.0 50.0

P12.12

11

0.0 3000.0 50.0

P12.13

12

0.0 3000.0 50.0

P12.14

13

0.0 3000.0 50.0

P12.15

M0

P12. 27			0.00 2.00 [s]	0.00 [s]	
P12. 28			0.00 2.00 [s]	0.07 [s]	
P12. 29			0.00 2.00 [s]	0.07 [s]	
P12. 32			0.0 20.0 [%]	0.0 [%]	
P12. 33			0.0 20.0 [%]	0.0 [%]	
P12. 34			0.00 2.00 [s]	0.00 [s]	
P12. 35			0.00 2.00 [s]	0.00 [s]	
P12. 36			0.00 2.00 [s]	0.50 [s]	
P12. 37			0.00 2.00 [s]	0.50 [s]	

10.12

2

P13

P13.0		[0] [1]	0 1	1	
P13.1		[0] [% [1] [Hz] [2] [rpm]	0 2	1	
P13.2	1		0.0 3000.0	10.0	
P13.3	2		0.0 3000.0	20.0	
P13.4	3		0.0 3000.0	35.0	
P13.5	4		0.0 3000.0	50.0	
P13.6	5		0.0 3000.0	50.0	
P13.7	6		0.0 3000.0	50.0	
P13.8	7		0.0 3000.0	50.0	
P13.9	8		0.0 3000.0	50.0	
P13.10	9		0.0 3000.0	50.0	
P13.11	10		0.0 3000.0	50.0	
P13.12	11		0.0 3000.0	50.0	
P13.13	12		0.0 3000.0	50.0	
P13.14	13		0.0 3000.0	50.0	
P13.15	14		0.0 3000.0	50.0	
P13.16	15		0.0 3000.0	50.0	
P13.17	16		0.0 3000.0	50.0	
P13.22			0.0 20.0 [%	2.0 [%	
P13.23			0.0 20.0 [%	0.0 [%	
P13.24			0.0 200.0 [%	30.0 [%	
P13.25			0.0 200.0 [%	20.0 [%	
P13.26			0.00 2.00 [s]	0.00 [s]	

P13. 27			0.00 2.00 [s]	0.00 [s]	
P13. 28			0.00 2.00 [s]	0.07 [s]	
P13. 29			0.00 2.00 [s]	0.07 [s]	
P13. 32			0.0 20.0 [%]	0.0 [%]	
P13. 33			0.0 20.0 [%]	0.0 [%]	
P13. 34			0.00 2.00 [s]	0.00 [s]	
P13. 35			0.00 2.00 [s]	0.00 [s]	
P13. 36			0.00 2.00 [s]	0.50 [s]	
P13. 37			0.00 2.00 [s]	0.50 [s]	

10.13

3

P14

P14.0		[0] [1]	0 1	1	
P14.1		[0] [%] [1] [Hz] [2] [rpm]	0 2	1	
P14.2	1		0.0 3000.0	10.0	
P14.3	2		0.0 3000.0	20.0	
P14.4	3		0.0 3000.0	35.0	
P14.5	4		0.0 3000.0	50.0	
P14.6	5		0.0 3000.0	50.0	
P14.7	6		0.0 3000.0	50.0	
P14.8	7		0.0 3000.0	50.0	
P14.9	8		0.0 3000.0	50.0	
P14.10	9		0.0 3000.0	50.0	
P14.11	10		0.0 3000.0	50.0	
P14.12	11		0.0 3000.0	50.0	
P14.13	12		0.0 3000.0	50.0	
P14.14	13		0.0 3000.0	50.0	
P14.15	14		0.0 3000.0	50.0	
P14.16	15		0.0 3000.0	50.0	
P14.17	16		0.0 3000.0	50.0	
P14.22			0.0 20.0 [%]	2.0 [%]	
P14.23			0.0 20.0 [%]	0.0 [%]	
P14.24			0.0 200.0 [%]	30.0 [%]	
P14.25			0.0 200.0 [%]	20.0 [%]	
P14.26			0.00 2.00 [s]	0.00 [s]	

P14. 27	0.00	2.00	0.00
	[s]		[s]
P14. 28	0.00	2.00	0.07
	[s]		[s]
P14. 29	0.00	2.00	0.07
	[s]		[s]
P14. 32	0.0	20.0	0.0
	[%]		[%]
P14. 33	0.0	20.0	0.0
	[%]		[%]
P14. 34	0.00	2.00	0.00
	[s]		[s]
P14. 35	0.00	2.00	0.00
	[s]		[s]
P14. 36	0.00	2.0000	0.50
	[s]		[s]
P14. 37		.00	0.50
		[s]	[s]

10.14

4

P15

P15. 27	0.00 2.00	0.00
	[s]	[s]
P15. 28	0.00 2.00	0.07
	[s]	[s]
P15. 29	0.00 2.00	0.07
	[s]	[s]
P15. 32	0.0 20.0	0.0
	[%	[%
P15. 33	0.0 20.0	0.0
	[%	[%
P15. 34	0.00 2.00	0.00
	[s]	[s]
P05. 35	0.00 2.00	0.00
	[s]	[s]
P15. 36	0.00 2.00	0.50
	[s]	[s]
P15. 37	0.00 2.00	0.50
	[s]	[s]

10.15 1 V/F P16

P16. 0			320 550 [V]	500 [V]	
P16. 2			0.0 4000.0 [kW]	[kW]	
P16. 3			320 520 [V]	500 [V]	
P16. 4			0.0 6500.0 [A]	[A]	
P16. 5			0.0 300.0 [Hz]	50.0 [Hz]	
P16. 6			0 6000 [rpm]	1465 [rpm]	
P16. 7			2 12 [pole]	4 [pole]	
P16. 9			0 7200 [rpm]	1500 [rpm]	
P16. 11		[0] V/F [1] [2] [3] [4]	0 4	0	
P16. 12			1.00 10.00 [kHz]	3.00 [kHz]	
P16. 14	V/F	[0] V/F [1] V/F [2]	0 3	0	
P16. 15		[0] [1]	0 1	0	
P16. 16			2 500 [ms]	500 [ms]	
P16. 17	V/F	[0] [1]	0 1	0	
P16. 18			10 1000 [ms]	200 [ms]	
P16. 19		[0] [1]	0 1	0	

P16. 22			0.00 100.00	0.00
			[s]	[s]
P16. 23		V/F	0.00 300.00	0.00
			[Hz]	[Hz]
P16. 24		V/F	0.00 300.00	50.00
			[Hz]	[Hz]
P16. 25			0.0 120.0	100.0
			[%	[%
P16. 26	V/F	V/F	0.00 10.00	0.75
			[%	[%
P16. 27			0.0 200.0	100.0
			[%	[%
P16. 30			0.0 100.0	0.0
			[%	[%
P16. 33	V/F	V/F	0 6	2
P16. 34	V/F		0.0 300.0	5.0
	1		[Hz]	[Hz]
P16. 35	V/F		0.0 12.0	
	1			



10.16 2 V/F P17

P17. 0			320 550 [V]	500 [V]	
P17. 2			0.0 4000.0 [kW]	[kW]	
P17. 3			320 520 [V]	500 [V]	
P17. 4			0.0 6500.0 [A]	[A]	
P17. 5			0.0 300.0 [Hz]	50.0 [Hz]	
P17. 6			0 6000 [rpm]	1465 [rpm]	
P17. 7			2 12 [pole]	4 [pole]	
P17. 9			0 7200 [rpm]	1500 [rpm]	
P17. 11		[0] V/F [1] [2] [3] [4]	0 4	0	
P17. 12			1.00 10.00 [kHz]	3.00 [kHz]	
P17. 14	V/F	[0] V/F [1] V/F [2]	0 3	0	
P17. 15		[0] [1]	0 1	0	
P17. 16			2 500 [ms]	500 [ms]	
P17. 17	V/F	[0] [1]	0 1	0	
P17. 18			10 1000 [ms]	200 [ms]	
P17. 19		[0] [1]	0 1	0	

P17. 22			0.00 100.00 [s]	0.00 [s]	
P17. 23		V/F	0.00 300.00 [Hz]	0.00 [Hz]	
P17. 24		V/F	0.00 300.00 [Hz]	50.00 [Hz]	
P17. 25			0.0 120.0 [%]	100.0 [%]	
P17. 26	V/F	V/F	0.00 10.00 [%]	0.75 [%]	
P17. 27			0.0 200.0 [%]	100.0 [%]	
P17. 30			0.0 100.0 [%]	0.0 [%]	
P17. 33	V/F	V/F	0 6	2	
P17. 34	V/F 1		0.0 300.0 [Hz]	5.0 [Hz]	
P17. 35	V/F 1		0.0 125.0 [%]	11.5 [%]	
P17. 36	V/F 2		0.0 300.0 [Hz]	50.0 [Hz]	
P17. 37	V/F 2		0.0 125.0 [%]	100.0 [%]	
P17. 38	V/F 3		0.0 300.0 [Hz]	50.0 [Hz]	
P17. 39	V/F 3		0.0 125.0 [%]	100.0 [%]	
P17. 40	V/F 4		0.0 300.0 [Hz]	50.0 [Hz]	
P17. 41	V/F 4		0.0 125.0 [%]	100.0 [%]	
P17. 42	V/F 5		0.0 300.0 [Hz]	50.0 [Hz]	
P17. 43	V/F 5		0.0 125.0 [%]	100.0 [%]	
P17. 44	V/F 6		0.0 300.0 [Hz]	50.0 [Hz]	
P17. 45	V/F 6		0.0 125.0 [%]	100.0 [%]	
P17. 46	V/F @		0 300	0	
P17. 47	@		0 300	0	

10.17 3 V/F P18

P18.0			320 550 [V]	500 [V]	
P18.2			0.0 4000.0 [kW]	[kW]	
P18.3			320 520 [V]	500 [V]	
P18.4			0.0 6500.0 [A]	[A]	
P18.5			0.0 300.0 [Hz]	50.0 [Hz]	
P18.6			0 6000 [rpm]	1465 [rpm]	
P18.7			2 12 [pole]	4 [pole]	
P18.9			0 7200 [rpm]	1500 [rpm]	
P18.11		[0] V/F [1] [2] [3] [4]	0 4	0	
P18.12			1.00 10.00 [kHz]	3.00 [kHz]	
P18.14	V/F	[0] V/F [1] V/F [2]	0 3	0	
P18.15		[0] [1]	0 1	0	
P18.16			2 500 [ms]	500 [ms]	
P18.17	V/F	[0] [1]	0 1	0	
P18.18			10 1000 [ms]	200 [ms]	
P18.19		[0] [1]	0 1	0	

P18. 22			0.00 100.00 [s]	0.00 [s]	
P18. 23		V/F	0.00 300.00 [Hz]	0.00 [Hz]	
P18. 24		V/F	0.00 300.00 [Hz]	50.00 [Hz]	
P18. 25			0.0 120.0 [%]	100.0 [%]	
P18. 26	V/F	V/F	0.00 10.00 [%]	0.75 [%]	
P18. 27			0.0 200.0 [%]	100.0 [%]	
P18. 30			0.0 100.0 [%]	0.0 [%]	
P18. 33	V/F	V/F	0 6	2	
P18. 34	V/F 1		0.0 300.0 [Hz]	5.0 [Hz]	
P18. 35	V/F 1		0.0 125.0 [%]	11.5 [%]	
P18. 36	V/F 2		0.0 300.0 [Hz]	50.0 [Hz]	
P18. 37	V/F 2		0.0 125.0 [%]	100.0 [%]	
P18. 38	V/F 3		0.0 300.0 [Hz]	50.0 [Hz]	
P18. 39	V/F 3		0.0 125.0 [%]	100.0 [%]	
P18. 40	V/F 4		0.0 300.0 [Hz]	50.0 [Hz]	
P18. 41	V/F 4		0.0 125.0 [%]	100.0 [%]	
P18. 42	V/F 5		0.0 300.0 [Hz]	50.0 [Hz]	
P18. 43	V/F 5		0.0 125.0 [%]	100.0 [%]	
P18. 44	V/F 6		0.0 300.0 [Hz]	50.0 [Hz]	
P18. 45	V/F 6		0.0 125.0 [%]	100.0 [%]	
P18. 46	V/F @		0 300	0	
P18. 47	@		0 300	0	

P18. 48		[0] [1] P I D 1 [2] P I D 2 [3]	0 3	0	
P18. 49	@		0 300	0	
P18. 50			0.00 300.00 [s]	0.00 [s]	
P18. 51			0.0 150.0 [%]	70.0 [%]	
P18. 52			0.00 5.00 [Hz]	0.00 [Hz]	
P18. 54			0.00 300.00 [s]	0.00 [s]	
P18. 55			0.0 150.0 [%]	75.0 [%]	
P18. 56			0.00 5.00 [Hz]	0.00 [Hz]	
P18. 59			0.0 1000.0 [%]	100.0 [%]	
P18. 60			0.0 1000.0 [%]	100.0 [%]	
P18. 61			0.0 1000.0 [%]	100.0 [%]	
P18. 62			0.0 1000.0 [%]	100.0 [%]	
P18. 64	V/F	V/F	0.0 1000.0 [%]	100.0 [%]	
P18. 66		V/F	0.0 1000.0 [%]	100.0 [%]	
P18. 67			0.0 1000.0 [%]	100.0 [%]	
P18. 68			0.0 1000.0 [%]	100.0 [%]	
P18. 69			0.0 1000.0 [%]	100.0 [%]	
P18. 70			0.0 1000.0 [%]	100.0 [%]	

10.18 4 V/F P19

PR

P19. 22			0.00	100.00	0.00
			[s]		[s]
P19. 23		V/F	0.00	300.00	0.00
			[Hz]		[Hz]
P19. 24		V/F	0.00	300.00	50.00
			[Hz]		[Hz]
P19. 25			0.0	120.0	100.0
			[%]		[%]
P19. 26	V/F	V/F	0.00	10.00	0.75
			[%]		[%]
P19. 27			0.0	200.0	100.0
			[%]		[%]
P19. 30			0.0	100.0	0.0
			[%]		[%]
P19. 33	V/F	V/F	0	6	2
P19. 34	V/F	1	0.0	300.0	5.0
			[Hz]		[Hz]
P19. 35	V/F	1	0.0	125.0	11.5
			[%]		[%]
P19. 36	V/F	2	0.0	300.0	50.0
			[Hz]		[Hz]
P19. 37	V/F	2	0.0	125.0	100.0
			[%]		[%]
P19. 38	V/F	3	0.0	300.0	50.0
			[Hz]		[Hz]
P19. 39	V/F	3	0.0	125.0	100.0
			[%]		[%]
P19. 40	V/F	4	0.0	300.0	50.0
			[Hz]		[Hz]
P19. 41	V/F	4	0.0	125.0	100.0
			[%]		[%]
P19. 42	V/F	5	0.0	300.0	50.0
			[Hz]		[Hz]
P19. 43	V/F	5	0.0	125.0	100.0
			[%]		[%]
P19. 44	V/F	6	0.0	300.0	50.0
			[Hz]		[Hz]
P19. 45	V/F	6	0.0	125.0	100.0
			[%]		[%]
P19. 46	V/F	@	0	300	0
P19. 47		@	0	300	0

10.19	1	P20		
P20.0		[0]		0 1 0
		[1]		
		[0]		
		[1]	1	
		[2]	2	
P20.1		[3]		0 7 0
		[4]	P20.3	
		[5] DP		
		[6] MODBUS		
		[7]		
P20.2				0 7 0
P20.3				-300.0 300.0 0.0
				[%] [%]
P20.4	@			0 300 0
P20.5				0 1000 0
				[ms] [ms]
P20.6				0.0 200.0 100.0
				[%] [%]
		[0]		
		[1]	P20.8	
		P20.9		
		[2]	1	
P20.7		[3]	2	0 7 0
		[4]		
		[5] DP		
		[6] MODBUS		
		[7]		
P20.8		P20.7	[1]	0.0 300.0 200.0
				[%] [%]
P20.9		P20.7	[1]	0.0 300.0 200.0
				[%] [%]
P20.10				0

P20. 31

0.0 100.0 5.0
[%] [%]

P20. 32

0.0 100.0 5.0
[%] [%]

E

o e i o p o

P20. 53	Kp			0. 0	1000. 0	100. 0
				[%]		[%]
P20. 54	Ki			0. 0	1000. 0	100. 0
				[%]		[%]
P20. 55				0. 0	1000. 0	100. 0
				[%]		[%]
P20. 56				0. 0	1000. 0	100. 0
				[%]		[%]
P20. 57		[0]		0	1	0
		[1]				
P20. 58				0. 0	125. 0	100. 0
				[%]		[%]
P20. 59				1. 0	25. 0	2. 5
				[%]		[%]
P20. 60	DROOP	0	DROOP	0. 0	100. 0	0. 0
				[%]		[%]
P20. 61	DROOP		DROOP	30	2000	50
				[ms]		[ms]
P20. 62				0. 0	1000. 0	100. 0
				[%]		[%]
P20. 63				0. 0	1000. 0	100. 0
				[%]		[%]
P20. 66		1		0. 0	1000. 0	100. 0
			1	[%]		[%]
P20. 67						

P20. 77	2	2	90. 0	110. 0	100. 0
			[%]		[%]
P20. 78			0. 00	650. 00	0. 00
			[nOhm]		[nOhm]
P20. 79			0. 00	65. 50	0. 000
			[mH]		[mH]
P20. 80	1	1	0. 800	1. 350	1. 140
P20. 81	2	2	0. 800	1. 350	0. 940
P20. 82	3	3	0. 800	1. 350	1. 080
P20. 83	4	4	0. 800	1. 350	0. 950
P20. 84			0. 00	655. 00	0. 00
			[mH]		[mH]
P20. 85	85%	85%	40. 0	150. 0	108. 0
			[%]		[%]
P20. 86	87. 5%	87. 5%	40. 0	150. 0	106. 5
			[%]		[%]
P20. 87	90%	90%	40. 0	150. 0	105. 0
			[%]		[%]
P20. 88	92. 5%	92. 5%	40. 0	150. 0	103. 5
			[%]		[%]
P20. 89	95%	95%	40. 0	150. 0	102. 0
			[%]		[%]
P20. 90	102. 5%	102. 5%	40. 0	150. 0	99. 0
5%			[%]		[%]
P20. 91	105%	105%	40. 0	150. 0	96. 5
			[%]		[%]
P20. 92	110%	110%	40. 0	150. 0	93. 0
			[%]		[%]
P20. 93	115%	115%	40. 0	150. 0	88. 5
			[%]		[%]
P20. 94	120%	120%	40. 0	150. 0	83. 0
			[%]		[%]
P20. 95	125%	125%	40. 0	150. 0	77. 0
			[%]		[%]
P20. 96	130%	130%	40. 0	150. 0	70. 5
			[%]		[%]
P20. 97	135%	135%	40. 0	150. 0	63. 5
			[%]		[%]
P20. 98		()	0. 01	300. 00	0. 75
			[s]		[s]
P20. 99			0. 00	10. 00	0. 00
			[%]		[%]



P21. 54

Ki

0.0 1000.0 100.0
[%] [%]

P21. 55

P21. 78

0. 00 650. 00 0. 00
[nChm] [nChm]

P21. 79

0. 00 65. 50 0. 000
[mH] [mH]

P21. 80

1

1

0. 800 1. 350 1. 140

P21. 81

2

2

0. 800 1. 350 0. 940

P21. 82

3

3

0. 800 1. 350 1. 080

P21. 83

4

4

0. 800 1. 350 0. 950

P21. 84

0. 00 655. 00 0. 00
[mH] [mH]

P21. 85

85% 85%

P22. 0		[0] [1]	0 1	0	
P22. 1		[0] [1] 1 [2] 2 [3] [4] P22. 3 [5] DP [6] MODBUS [7]	0 7	0	
P22. 2			0 7	0	
P22. 3			-300.0 300.0 [%]	0.0 [%]	
P22. 4	@		0 300	0	
P22. 5			0 1000 [ms]	0 [ms]	
P22. 6			0.0 200.0 [%]	100.0 [%]	
P22. 7		[0] [1] P22. 8 P22. 9 [2] 1 [3] 2 [4] [5] DP [6] MODBUS [7]	0 7	0	
P22. 8		P22. 7 [1]	0.0 300.0 [%]	200.0 [%]	
P22. 9		P22. 7 [1]	0.0 300.0 [%]	200.0 [%]	
P22. 10			0 300	0	
P22. 11			0 1000 [ms]	0 [ms]	

P22. 31

0.0 100.0 5.0
[%] [%]

P22. 32

0.0 100.0 5.0
[%] [%]

P22. 34

[0]
[1]

0 1 0

P22. 35

0.0 100.0 0.0
[s] [s]

P22. 36

50.0 150.0 110.0
[%] [%]

P22. 37

0.0 150.0 100.0
[%] [%]

P22. 38

0.0 100.0 25.0
[%] [%]

P22. 39

0.0 120.0 100.0
[%] [%]

P22. 40

0.0 150.0 100.0
[%] [%]

P22. 41

0.0 150.0 135.0
[%] [%]

P22. 42

0 1 1

P22. 43

2

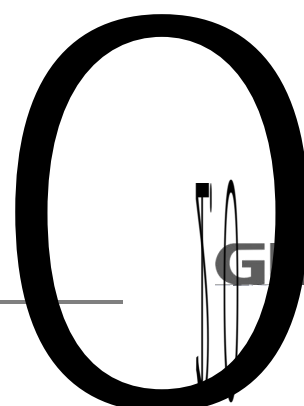
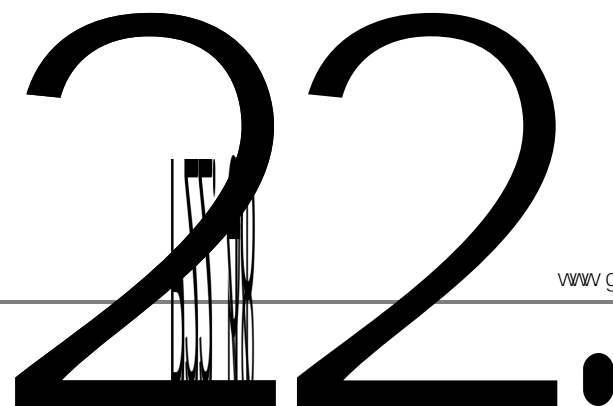
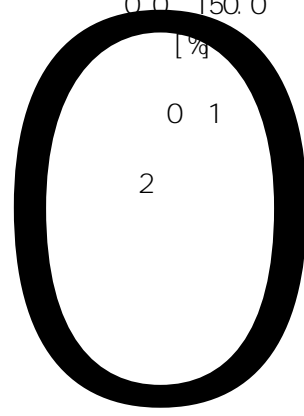
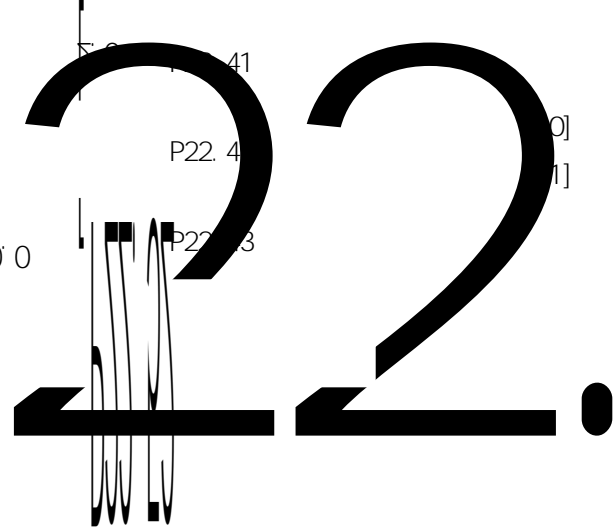

P22. 53	Kp	0. 0	1000. 0	100. 0
			[%	[%
P22. 54	Ki	0. 0	1000. 0	100. 0
			[%	[%
P22. 55		0. 0	1000. 0	



10. 22

4

P23

P23. 0

E

2

D

人
..

P23. 54	Ki		0. 0 1000. 0 [%]	100. 0 [%]	
P23. 55			0. 0 1000. 0 [%]	100. 0 [%]	
P23. 56			0. 0 1000. 0 [%]	100. 0 [%]	
P23. 57		[0] [1]	0 1	0	
P23. 58			0. 0 125. 0 [%]	100. 0 [%]	
P23. 59			1. 0 25. 0 [%]	2. 5 [%]	
P23. 60	DROOP	0 DROOP	0. 0 100. 0 [%]	0. 0 [%]	
P23. 61	DROOP	DROOP	30 2000 [ms]	50 [ms]	
P23. 62			0. 0 1000. 0 [%]	100. 0 [%]	
P23. 63			0. 0 1000. 0 [%]	100. 0 [%]	
P23. 66	1	1	0. 0 1000. 0 [%]	100. 0 [%]	
P23. 67	2	2	0. 0 1000. 0 [%]	100. 0 [%]	
P23. 69			0. 00 2. 00 [%]	1. 00 [%]	
P23. 70			0. 00 2. 00 [%]	1. 00 [%]	
P23. 71		[0] [1]	0 1	0	
P23. 72		[0] [1]	0 1	1	
P23. 73		[0] × 1 [1] × 10	0 1	0	
P23. 74			0. 00 650. 00 [nChm]	0. 00 [nChm]	
P23. 75			0. 70 1. 00	0. 90	
P23. 76	1	1	90. 0 110. 0 [%]	100. 0 [%]	
P23. 77	2	2	90. 0 110. 0 [%]	100. 0 [%]	

P23. 78			0. 00	650. 00	0. 00
			[nChm]		[nChm]
P23. 79			0. 00	65. 50	0. 000
			[nH]		[nH]
P23. 80	1	1	0. 800	1. 350	1. 140
P23. 81	2	2	0. 800		

10. 23

P33

P33. 0	Profi bus	[0]	0	1	0
		[1]			
P33. 1		PLC	1	255	1
		[0] PPO 1			
P33. 2		[1] PPO 2	0	3	2
		[2] PPO 5			
		[3] GUI DE			
P33. 3			0	16	14
P33. 4			ON		

E

[J]
[0]

P33. 31	[WØ]	7-2	0 37	0
P33. 32	[WØ]	[0] × 1 [1] × 10 [2] × 100 [3] × 1000 [4] × 10000	0 4	0
P33. 33	[W0]	7-2	0 37	0
P33. 34	[W0]	[0] × 1 [1] × 10 [2] × 100 [3] × 1000 [4] × 10000	0 4	0
P33. 35	[W1]	7-2	0 37	0
P33. 36	[W1]	[0] × 1 [1] × 10 [2] × 100 [3] × 1000 [4] × 10000	0 4	0
P33. 37	[W2]	7-2	0 37	0
P33. 38	[W2]	[0] × 1 [1] × 10 [2] × 100 [3] × 1000 [4] × 10000	0 4	0
P33. 39	[W3]	7-2	0 37	0
P33. 40	[W3]	[0] × 1 [1] × 10 [2] × 100 [3] × 1000 [4] × 10000	0 4	0
P33. 41	[W4]	7-2	0 37	0
P33. 42	[W4]	[0] × 1 [1] × 10 [2] × 100 [3] × 1000 [4] × 10000	0 4	0
P33. 43	[W5]	7-2	0 37	0

P33. 44	[W5]	[0] × 1 [1] × 10 [2] × 100 [3] × 1000 [4] × 10000	0 4	0	
P33. 45	[V0]	7-3	0 48	0	
P33. 46	[V0]	[0] × 1 [1] × 10 [2] × 100 [3] × 1000 [4] × 10000 [5] [% × 1 [6] [% × 10 [7] [% × 100	0 7	0	
P33. 47	[W1]	7-3	0 48	0	
P33. 48	[W1]	[0] × 1 [1] × 10 [2] × 100 [3] × 1000 [4] × 10000 [5] [% × 1 [6] [% × 10 [7] [% × 100	0 7	0	
P33. 49	[V2]	7-3	0 48	0	
P33. 50	[V2]	[0] × 1 [1] × 10 [2] × 100 [3] × 1000 [4] × 10000 [5] [% × 1 [6] [% × 10 [7] [% × 100	0 7	0	
P33. 51	[V3]	7-3	0 48	0	
P33. 52	[V3]	[0] × 1 [1] × 10 [2] × 100 [3] × 1000 [4] × 10000 [5] [% × 1 [6] [% × 10 [7] [% × 100	0 7	0	
P33. 53	[W4]	7-3	0 48	1	

P33. 54	[W4]	[0] × 1 [1] × 10 [2] × 100 [3] × 1000 [4] × 10000 [5] [%] × 1 [6] [%] × 10 [7] [%] × 100	0 7	0	
P33. 55	[W5]	7-3	0 48	19	
P33. 56	[W5]	[0] × 1 [1] × 10 [2] × 100 [3] × 1000 [4] × 10000 [5] [%] × 1 [6] [%] × 10 [7] [%] × 100	0 7	2	
P33. 57	[W6]	7-3	0 48	26	
P33. 58	[W6]	[0] × 1 [1] × 10 [2] × 100 [3] × 1000 [4] × 10000 [5] [%] × 1 [6] [%] × 10 [7] [%] × 100	0 7	6	
P33. 59	[W7]	7-3	0 48	30	
P33. 60	[W7]	[0] × 1 [1] × 10 [2] × 100 [3] × 1000 [4] × 10000 [5] [%] × 1 [6] [%] × 10 [7] [%] × 100	0 7	1	
P33. 61	[W8]	7-3	0 48	14	

P33. 62
[V8]

[0] × 1
[1] × 10
[2] × 100
[3] × 1000
[4] × 10000
[5] [% × 1
[6] [% × 10
[7] [% × 100

0



7-2

0	
1	0
2	1
3	2
4	3
5	4
6	[32]
7	[32]
8	32_MSW
9	32_LSW
10	
11	
12	0 @32bi t
13	1 @32bi t
14	2 @32bi t
15	3 @32bi t
16	4 @32bi t
17	5 @32bi t
18	[Hz]
19	[rpm]
20	[%]
21	[%]
22	[%]
23	[Hz]
24	
25	
26	1[%]
27	2[%]
28	
29	
30 37	SET_W12 19

7-3

0	
1	0
2	1
3	2
4	3
5	4
6	5
7	0 @32bi t
8	1 @32bi t
9	2 @32bi t
10	3 @32bi t
11	4 @32bi t
12	5 @32bi t
13	[32]
14	[32]
15	32bi t_MSW
16	32bi t_LSW
17	
18	
19	
20	[rpn]
21	[rpn]
22	
23	
24	
25	
26	
27	A
28	B

29	C
30	
31	
32	
33	1
34	2
35	
36	
37	
38	
39	
40	
41 48	AV22 29

11.

11.1

! Ę! Ę! Ę! Ę!

V01	SYS_NOT_RDY	(Ready)			
V02	NO_DRV_ENABLE		[P3
V03	LOCAL_EM		[P3
V04	REMOTE_EM		[P3
V06	O.T)		P7.14(
V09	DP	DP			DP
V10	MODBUS	Modbus			Modbus
V15	PARAMETER ERROR				
V18	Temp_Sensing Fail				
V20	SLV_NOT_RDY				
V21	1		1		1
V22	2		2	ž AŃ j FJAŃi Ę	2
V23	3		3		

[E113]	MP	
[E114]	MP	
[E115]	OS	P7. 19 P7. 19
[E116]	SLVC Fai l	P7. 23
[E117]	MOTOR STALL	P20. 14 P20. 15
[E118]	PG ERROR	P20. 14 P20. 15
[E119]	SPEED ABNORMAL	P20. 14 P20. 15 P7. 31 P7. 32
[E121]	I GBT1 OT1	
[E122]	I GBT2 OT2	
[E123]	I GBT3 OT3	
[E124]	I GBT4 OT4	
[E125]	I GBT5 OT5	
[E126]	I GBT6 OT6	
[E127]	I GBT7 OT7	
[E128]	I GBT8 OT8	
[E137]	FAN STALL	

[E138]	TEMP_SENSI NG FAI L		
[E139]	Pre_Chargi ng Fai l		P7. 95
[E140]	Li ne UV		
[E141]	Li ne OPEN		
[E142]	Li ne Detecti on Error		
[E143]	Li ne SWFai l	DI	
[E144]	Li ne SWSHORT		
[E145]	(AFE) Li ne OV		P16. 0
[E146]	(AFE) Li ne Over_Freq		
[E151]	U IGBT PDP [UT]	I GBT I GBT	
[E152]	U IGBT PDP [UB]	I GBT I GBT	
[E153]	V IGBT PDP [VT]	I GBT I GBT	
[E154]	V IGBT PDP [VB]	I GBT I GBT	
[E155]	W IGBT PDP [WT]	I GBT I GBT	
[E156]	W IGBT PDP [WB]	I GBT I GBT	

Q
1.3

GB3

• ON COM)

• ON COM (

•)

•

•

12 2

1.
2

1.
2

1.
2
3

1. > 40
< 95%

2

1.
2

1.
2
3

1



5



(400-0077-570)

- 1 40
- 2 80%
- 3 24 /

12 5

1 J R ñ

2

P Ø

5

FJ

X

= 9



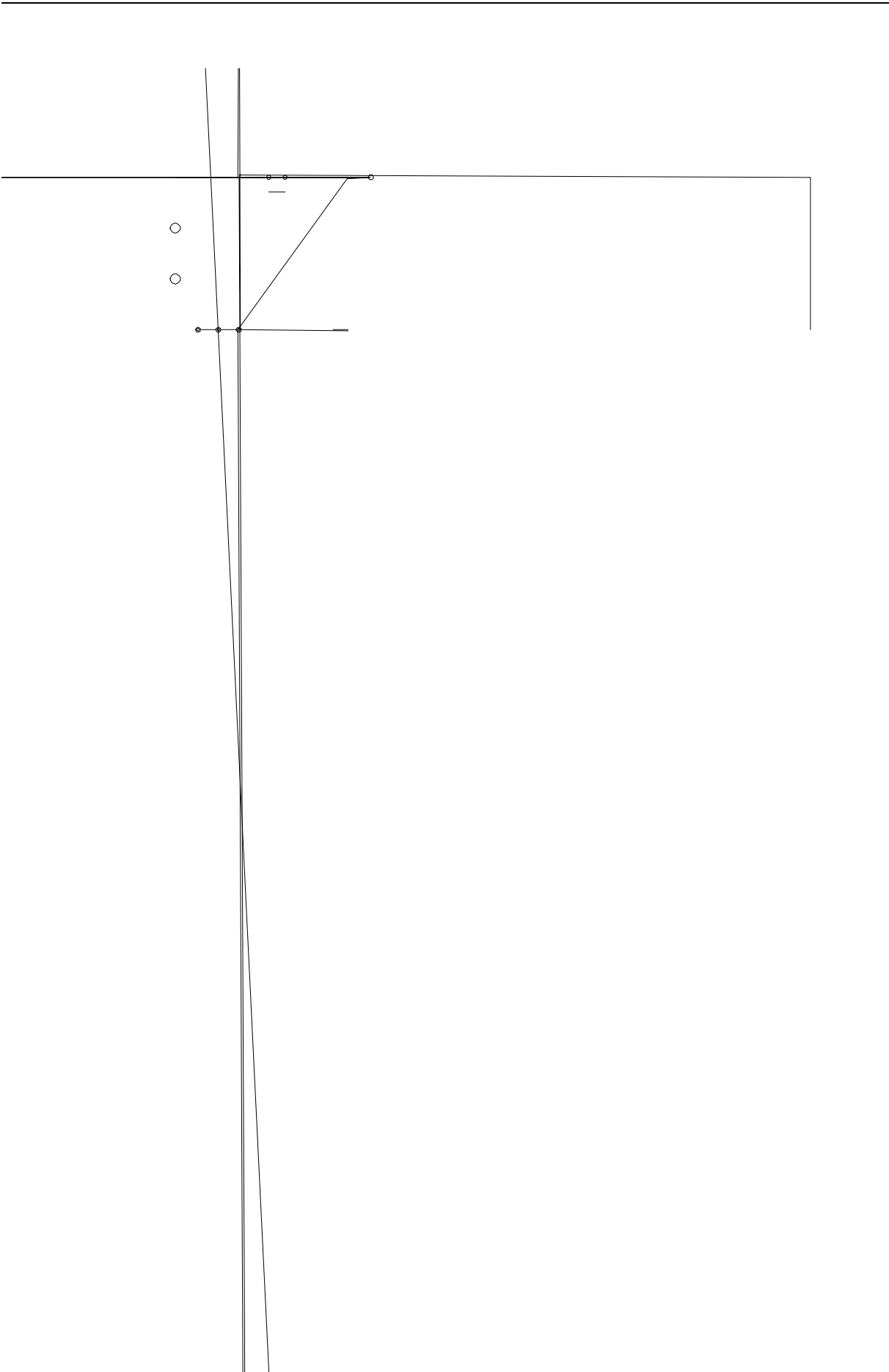



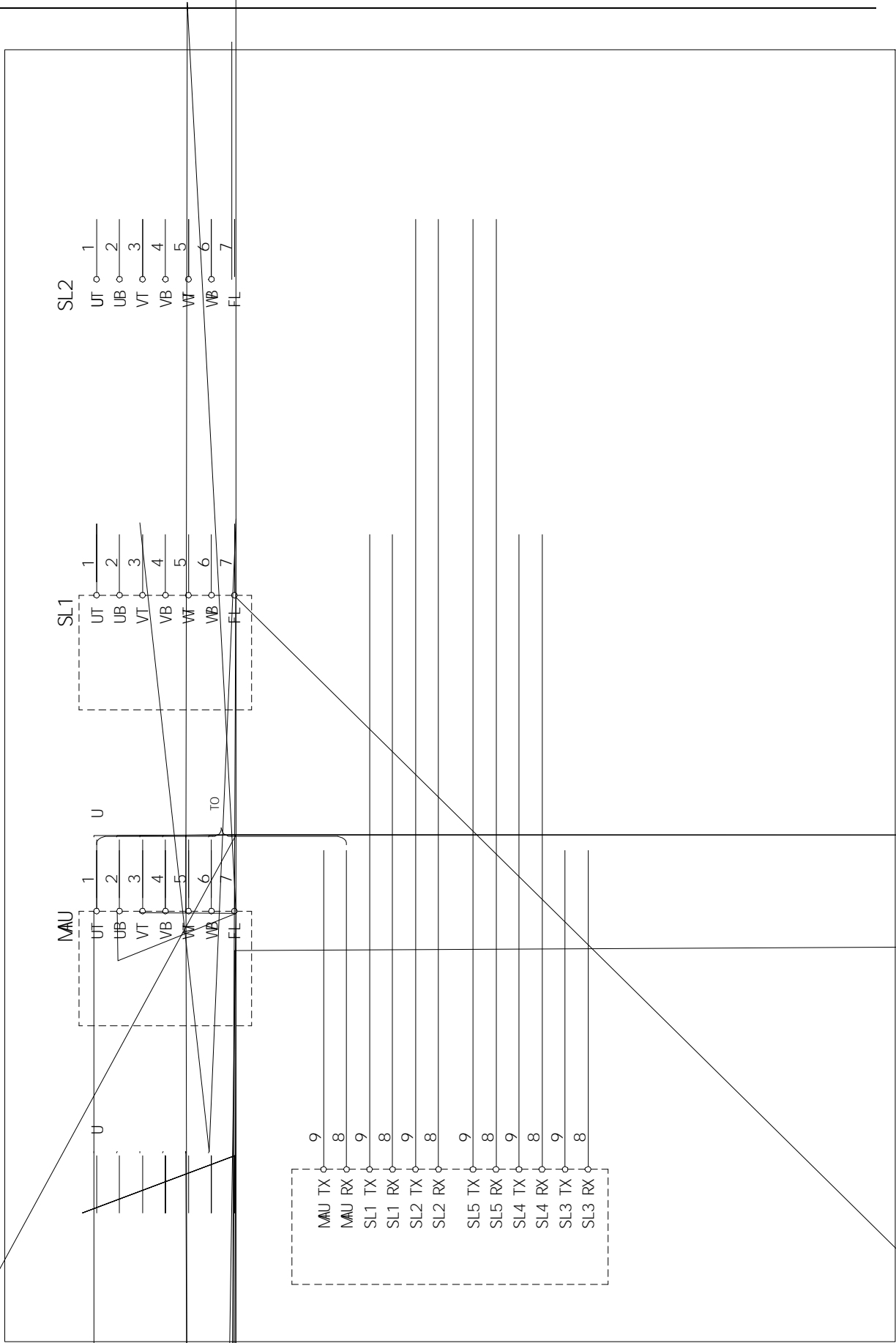

HF680N-5

1.01

GUIDE

1
2
3

Wuhan Guide Technology Co., Ltd.

6

430223

86-027-87927230

shfw@gdetec.com

www.gdetec.com

400-0077-570

Wuhan Guide Technology Co., Ltd.